

C E R T I F I E D

ISO 9001:2000-ISO13485:2003-CE Marked & cGMP/FDA Approved

General Surgical Catalogue
Chirurgie - Katalog

Percussion Hammers and Aesthesiometers
 Reflexhammer und Sensibilitätsinstrumente



01-101
 TROEMNER
 Size: 245 mm



01-102
 DEJERINE
 Size: 200 mm



01-103
 DEJERINE
 with needle
 Size: 210 mm



01-104
 TAYLOR
 Size: 195 mm



01-105
 BERLINER
 Size: 200 mm

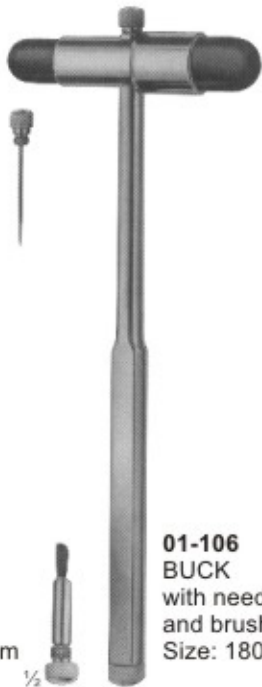

01-106
 BUCK
 with needle
 and brush
 Size: 180 mm



01-107
 RABINER
 with needle
 and brush
 Size: 255 mm



01-108
 ALY
 Size: 190 mm



01-109
 WARTENBERG
 Pinwheel for
 neurological
 examination
 Size: 185 mm

Stethoscopes
Stethoskope



01-110
PINARD (Aluminum)
Size: 155 mm

½



01-111
wooden
Size: 145 mm

½



01-112
BOWLES
Stethoscope
with diaphragm

¼



01-113
ANESTOPHON

½



01-114
FORD-BOWLES
Dual chest piece
with two outlets

¼



01-115
BOWLES

¼

Head Mirrors and Head Bands Reflexspiegel und Stirnbänder



01-116
ZIEGLER Ø 90mm
head mirror only
with rubber coating

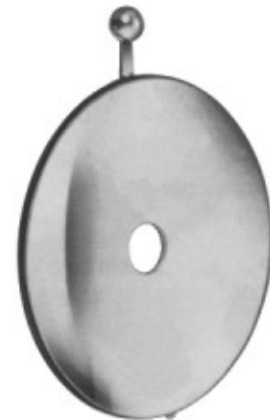

01-117
ZIEGLER Ø 90mm
head mirror only
with metal coating



01-118
ZIEGLER
head band of plastic black

01-119
ZIEGLER
head band of plastic white



01-120
MURPHY
head band of celluloid, white



01-121
head band of plastic,
white, soft pattern



01-122
head mirror with black
plastic head band.

Tongue Depressors Zungenspatel

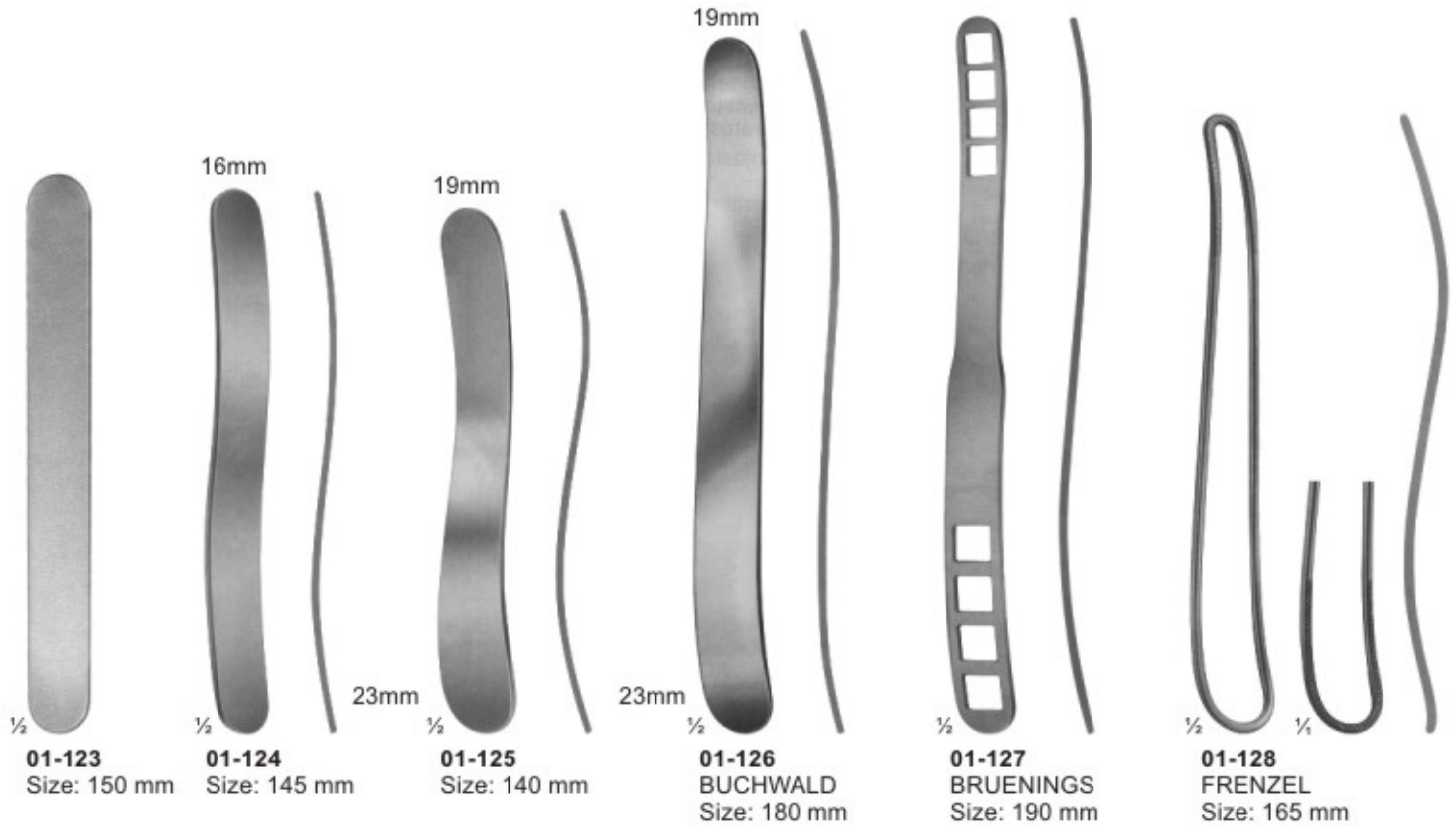

Instruments for Anaesthesia and Tongue Forceps

Narkoseinstrumente und Zungenzangen



1/2
01-134
SCHIMMELBUSCH
Ether mask



1/2
01-135
HEISTER
Mouth gag
Size: 130 mm



1/2
01-136
FERGUSSON-ACKLAND
Mouth gag
Size: 145 mm



1/2
01-137
DENHARDT
Mouth gag with silicon
inserts, interchangeable
Size: 125 mm



1/2
01-138
ROSER KOENIG
Mouth gag
Size: 160 mm, 185 mm

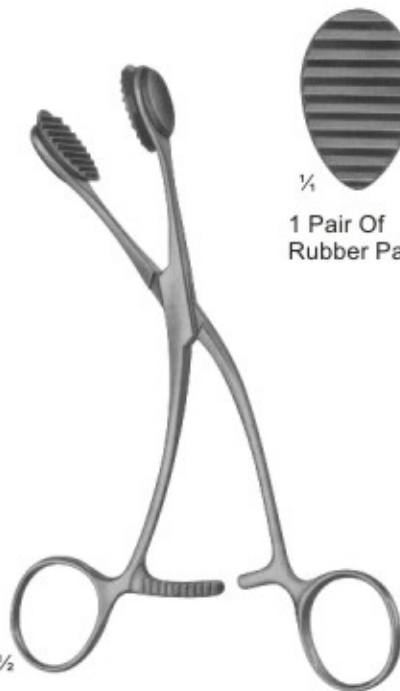

1/2
01-139
YOUNG
Size: 165 mm



1/4
1 Pair Of
Rubber Pads



1/2
01-140
COLLIN
Size: 160 mm, 170 mm



1/4
Size: 160 mm



1/4
Size: 170 mm



1/2
01-141
HEYWOOD-SMITH modif.
Size: 215 mm

Blood Lancets and Laryngeal Mirrors

Blutentnahmenadeln und Kehlkopfspiegel



01-142
FRANCKE
Automatic blood lancet



01-143
Laryngeal mirrors with
hexagonal handle
Size: 180 mm

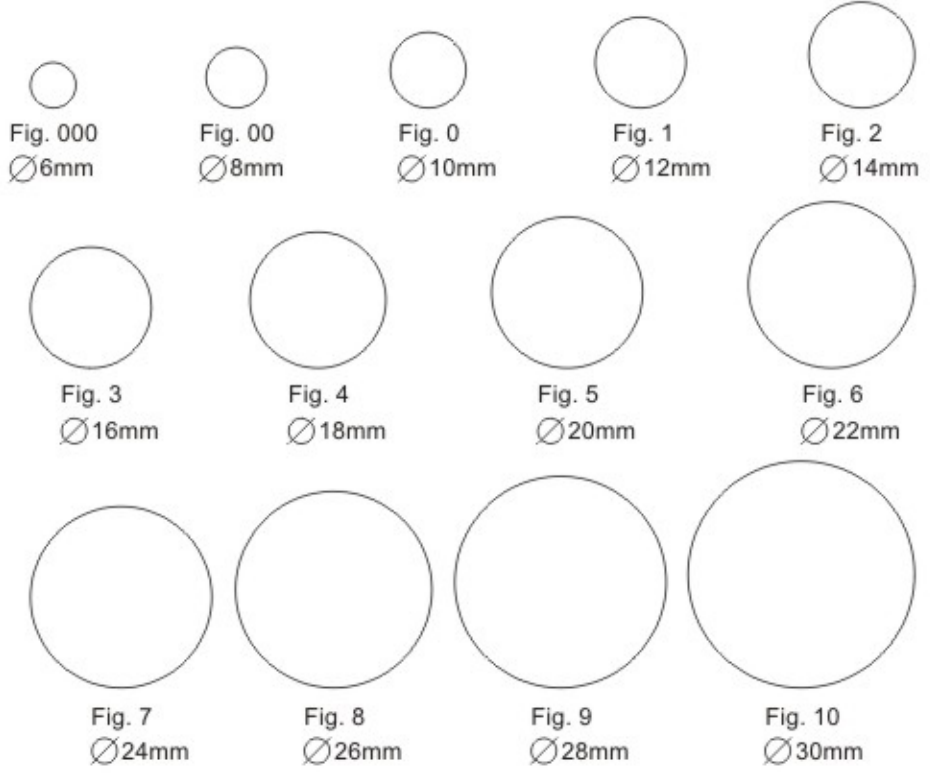

01-148
Spare mirrors only
Size: 12 mm



01-149
Spare mirrors only
Size: 14 mm



01-144
KOLLE
Microscopic Needle
Holder with plastic handle
Size: 240 mm



01-145
Mirror handle
Size: 110 mm



01-146
Mirror handle
Size: 105 mm



01-147
MICHEL
Rhinoscopic mirrors with
interchangeable mirror inserts
Size: 250 mm

Laryngoscope and Diagnostic Sets

Laryngoskope und Diagnostikbestecke



1/2

01-150 - 152
MAGILL



01-150
Infants
Size: 150 mm



01-151
Children
Size: 200 mm



01-152
Adults
Size: 250 mm



1/2

01-153
Medium battery handle
only, 25 mm diam.



01-153-A
Spare bulb
2.7 volt, for
otoscopes



01-153-B
Spare bulb
2.6 volt, for
ophthalmoscopes



01-154
Otoscope set, consists of
battery handle without batteries,
3 ear specula, 1 bulb in velvet lined case



01-155
Diagnostic set, otoscope with three specula,
nasal speculam, lamp holder, two laryngeal
mirrors, tongue blade holder

Laryngoscopes Laryngoskope



**01-156
MILLER**
Laryngoscope set, consists of battery handle (without battery)
with four miller laryngoscope blades

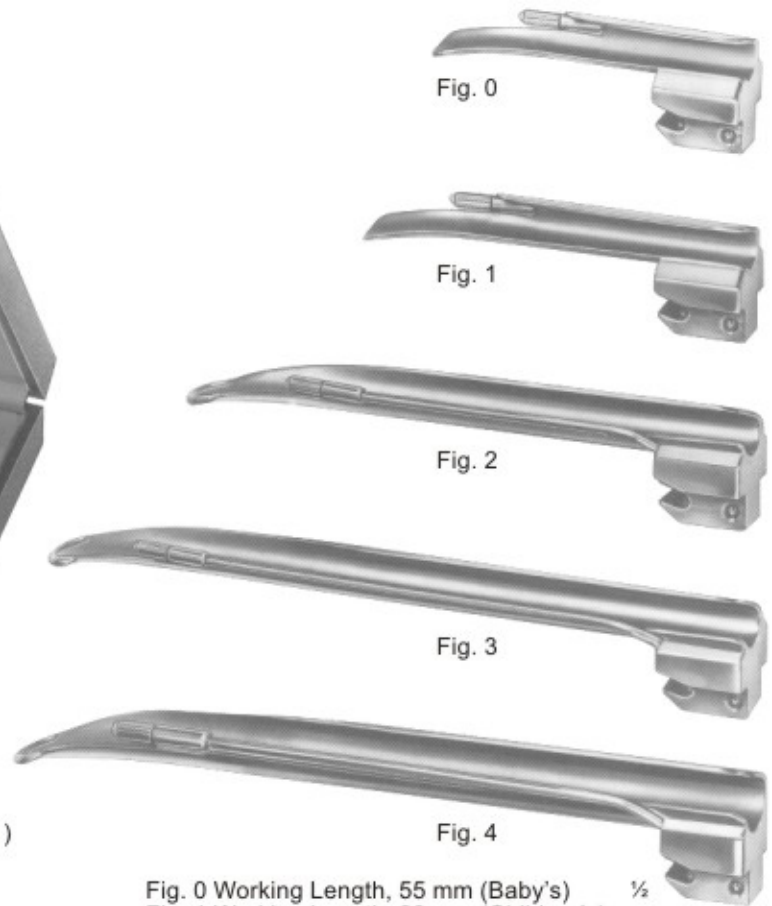

Fig. 0 Working Length, 55 mm (Baby's) $\frac{1}{2}$
 Fig. 1 Working Length, 80 mm (Children's)
 Fig. 2 Working Length, 130 mm (Adolescent's)
 Fig. 3 Working Length, 170 mm (Women's)
 Fig. 4 Working Length, 180 mm (Men's)



**01-157
GUEDEL-NEGUS**
Laryngoscope set, consists of battery handle (without battery)
with four miller laryngoscope blades

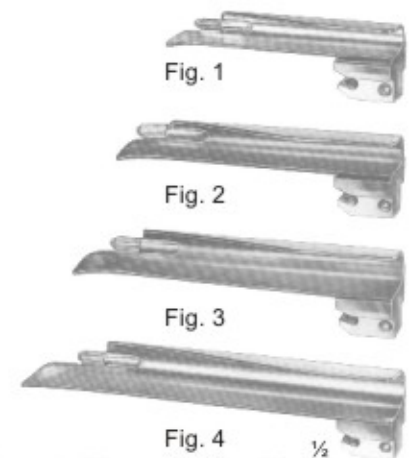

Fig. 1 Working Length, 70 mm (Children's) $\frac{1}{2}$
 Fig. 2 Working Length, 90 mm (Adolescent's)
 Fig. 3 Working Length, 110 mm (Women's)
 Fig. 4 Working Length, 135 mm (Men's)

Dissecting Knives Anatomische Skalpelle



1/2

02-101 - 110
Fig. 1 - 10



1/4

02-101
Fig. 1
30 mm



02-102
Fig. 2
36 mm



02-103
Fig. 3
40 mm



02-104
Fig. 4
45 mm



02-105
Fig. 5
50 mm



1/4

02-106
Fig. 6
27 mm



02-107
Fig. 7
35 mm



02-108
Fig. 8
40 mm



02-109
Fig. 9
47 mm



02-110
Fig. 10
50 mm



LISTON
02-111
 Size: 130 mm
02-112
 Size: 160 mm
02-113
 Size: 190 mm
02-114
 Size: 200 mm

02-115
CATLIN
 Size: 160 mm
 Blade length
 Amputating
 Knives

02-116
LANGENBECK
 Size: 120 mm
 Blade length
 Flap Knives

02-117
 Size: 110 mm
 Blade length
 Interosseous
 Knives

02-118
 Size: 55 mm
 Blade length
 with raspatory,
 Wooden handle

02-119
 Size: 70 mm
 Blade length
 Wooden handle

02-120
 Size: 80 mm
 Blade length
 Metal handle

02-121
 Size: 195 mm
 Blade length
 Metal handle

Blade length
 Amputating Knives

Cone Knives, Myomatome, Trigeminal and Tonsil Knives
Konisationsmesser, Myommesser, Trigeminus und
Tonsillenmesser



02-122

AYRE

Size: 235 mm
Cone Knife

02-123

SEGOND

Size: 230 mm

Cone Knife

02-124

OLIVECRONA

Size: 270 mm
Myomatome

02-125

FOWLER

Size: 205 mm
Trigeminal
Knife

02-126

ABRAHAM

Size: 230 mm
Trigeminal
Knife

02-127

BRUNINGS

Size: 200 mm
Tonsil Knife

02-128

ABRAHAM

Size: 215 mm
Tonsil Knife

02-129

BRUNINGS

Size: 215 mm
Tonsil Knife

**Scalpel Handles
Skalpellgriffe**

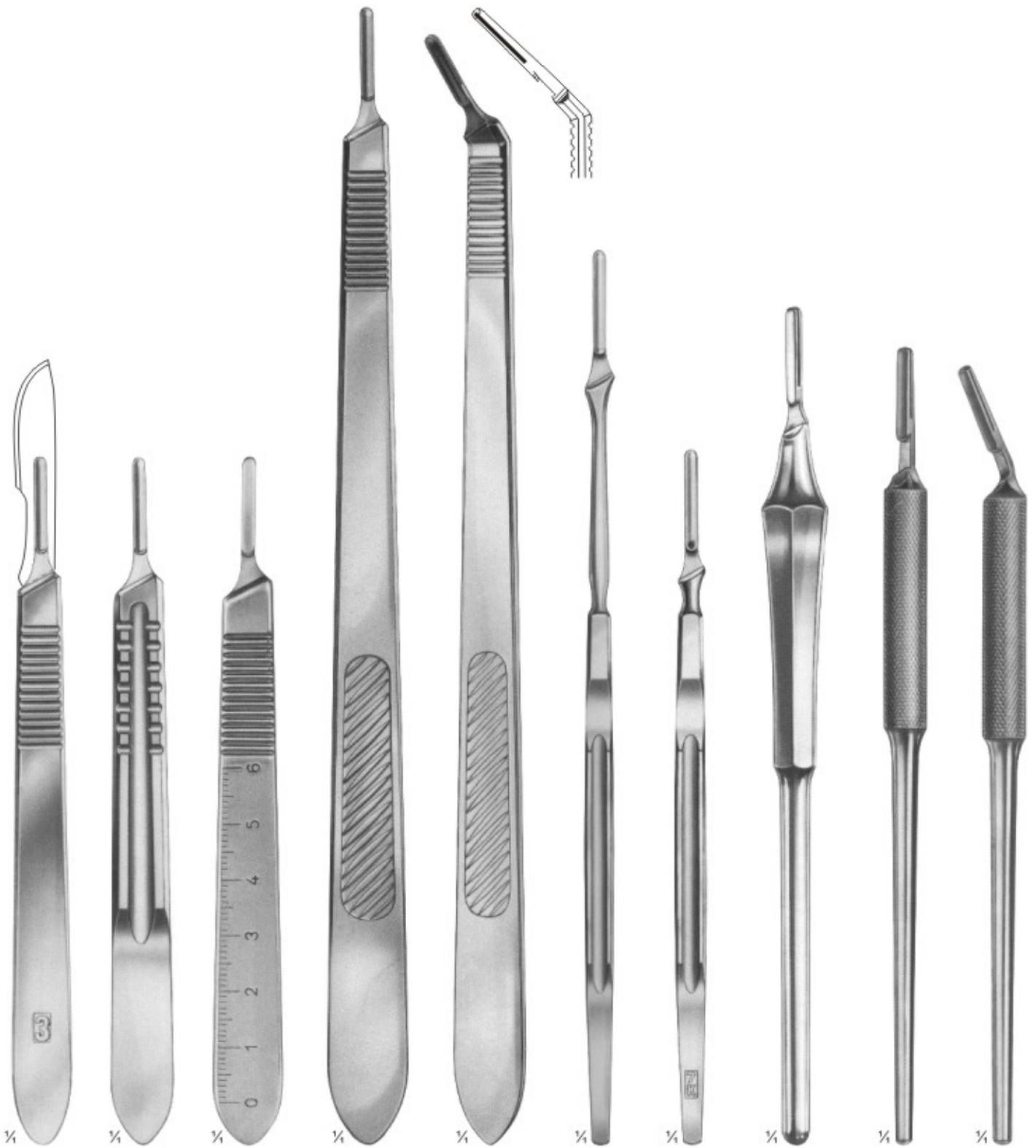

- | | | | | | | | | | |
|------------------------------------------------------|------------------------------------------|------------------------------------------|----------------------------------------------------------|------------------------------------------------------|------------------------------------------|----------------------------------------------|------------------------------------------|------------------------------------------------------------------|--------------------------------------------------------------|
| ¼ | ¼ | ¼ | ¼ | ¼ | ¼ | ¼ | ¼ | ¼ | ¼ |
| 02-130
STANDARD
No. 3
Solid
12 cm | 02-131
No. 3
Solid
12 cm | 02-132
No. 3
Solid
12 cm | 02-133
No. 3 L
Straight
Solid
21.5 cm | 02-134
No. 3 L
Angled
Solid
21 cm | 02-135
No. 7
Solid
16 cm | 02-136
No. 7 K
Solid
12.5 cm | 02-137
Hollow-Round
15.5 cm | 02-138
No. 3
Straight
Solid,
Round
14.5 cm | 02-139
No. 3
Angled
Solid,
Round
14 cm |

Micro Scissors (Spring Type) with Flat Handles
Mikro-Federscheren mit Flachgriffen

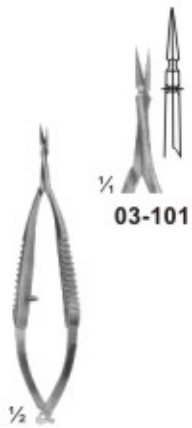

03-101 - 103
VANNAS
 Size: 85 mm



03-101



03-102



03-103



03-104 - 105
CASTROVIEJO
 Size: 95 mm



03-104



03-105

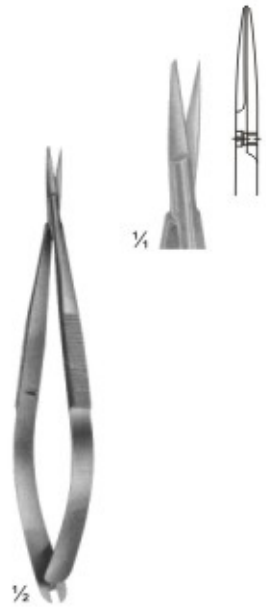

03-106
NOYES
 Size: 125 mm

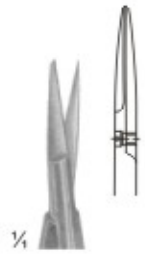

03-106

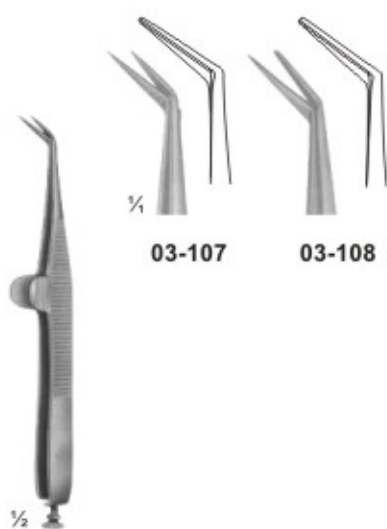

03-107 - 108
WECKER
 Eye scissor
 Size: 110 mm



03-107



03-108



03-109
CASTROVIEJO
 Eye scissor
 Size: 115 mm



03-109

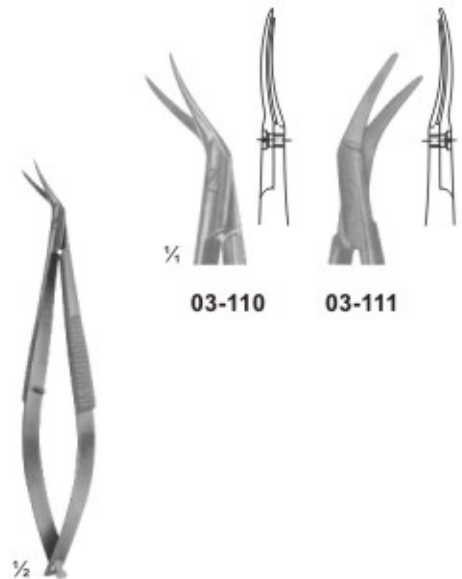

03-110 - 111
CASTROVIEJO
 Eye scissor
 Size: 110 mm



03-110



03-111

Micro Scissors (Spring Type) with Flat Handles Mikro-Federscheren mit Flachgriffen

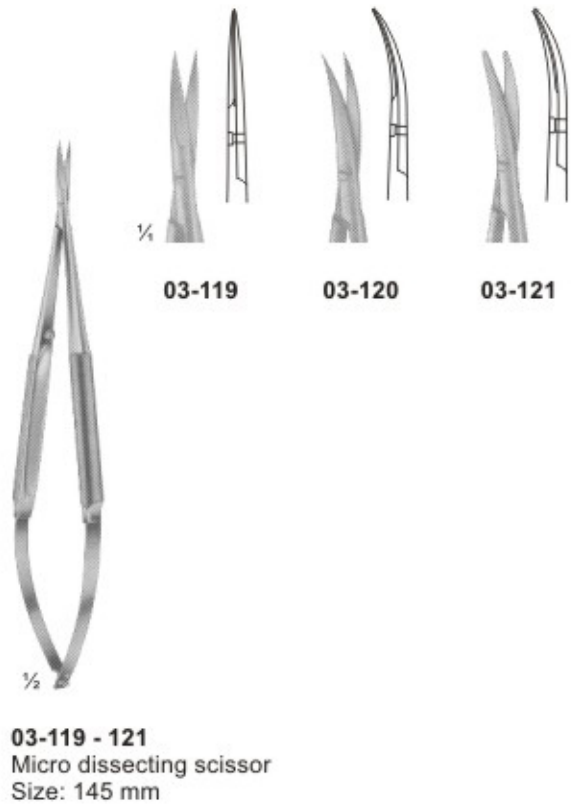
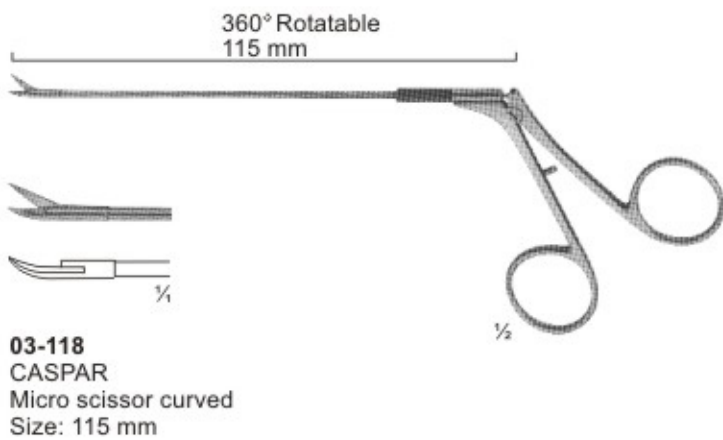
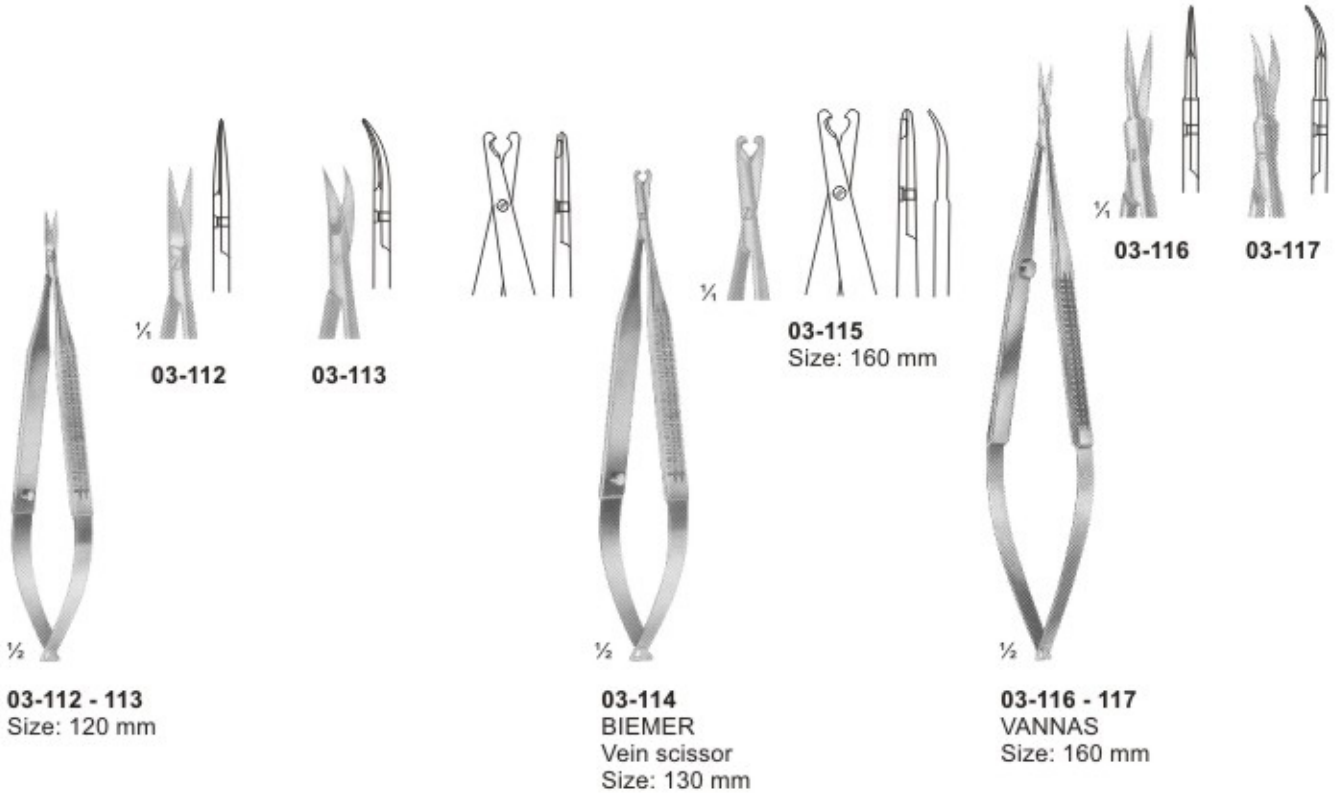

Micro Scissors (Spring Type) bayonet-Shaped
Mikro-Federscheren, bajonettformig



1/2
03-122
YASARGIL
 Size: 245 mm



1/4
03-123
 45°



1/4
03-124
 45°



1/2
03-123 - 124
 laterally angled
 Size: 200 mm



125°



1/2
03-125
 laterally angled
 Size: 190 mm

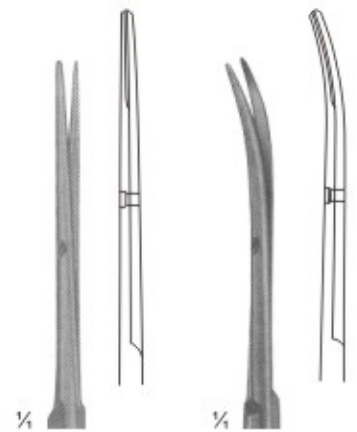

1/4
03-126

1/4
03-127



1/2
03-126 - 127
YASARGIL
 Size: 225 mm

Delicate Scissors Feine Scheren



03-128

03-129

03-128 - 129
Size: 90 mm

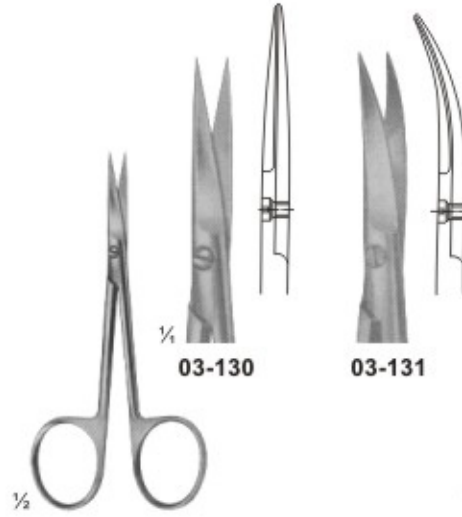

03-130

03-131

03-130 - 131
Size: 95 mm

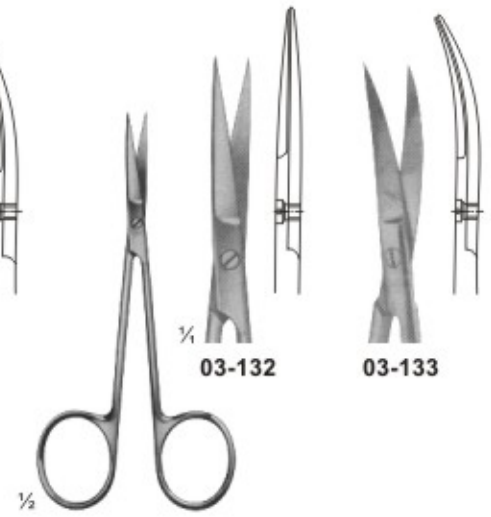

03-132

03-133

03-132 - 133
Size: 105 mm

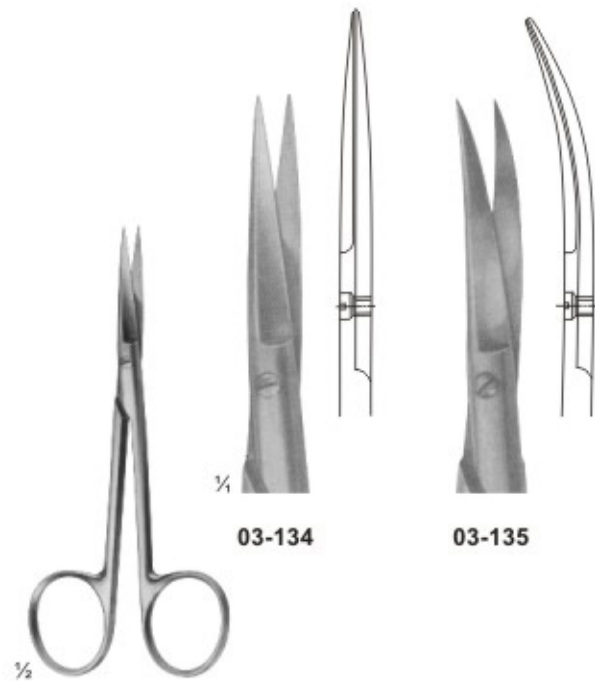

03-134

03-135

03-134 - 135
Size: 120 mm



03-136

03-137

03-136 - 137
Size: 115 mm

Delicate Scissors
Feine Scheren



03-138 - 140
Size: 120 mm



03-138

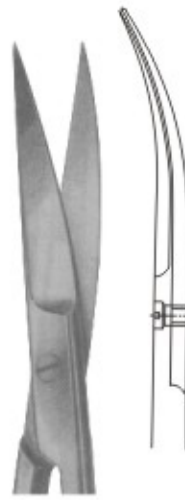

03-139



03-140



03-141 - 144
Size: 130 mm

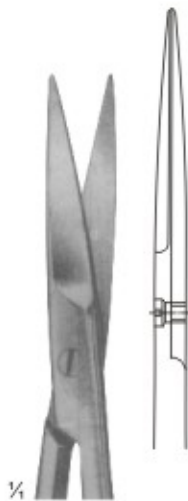

03-141

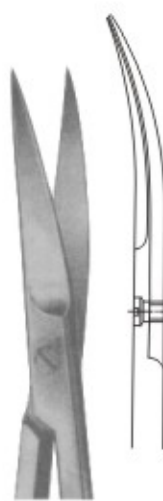

03-142

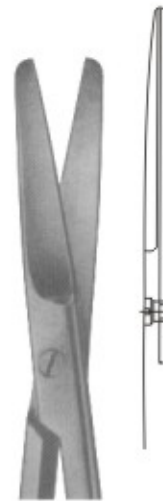

03-143



03-144

Surgical Scissors Chirurgische Scheren

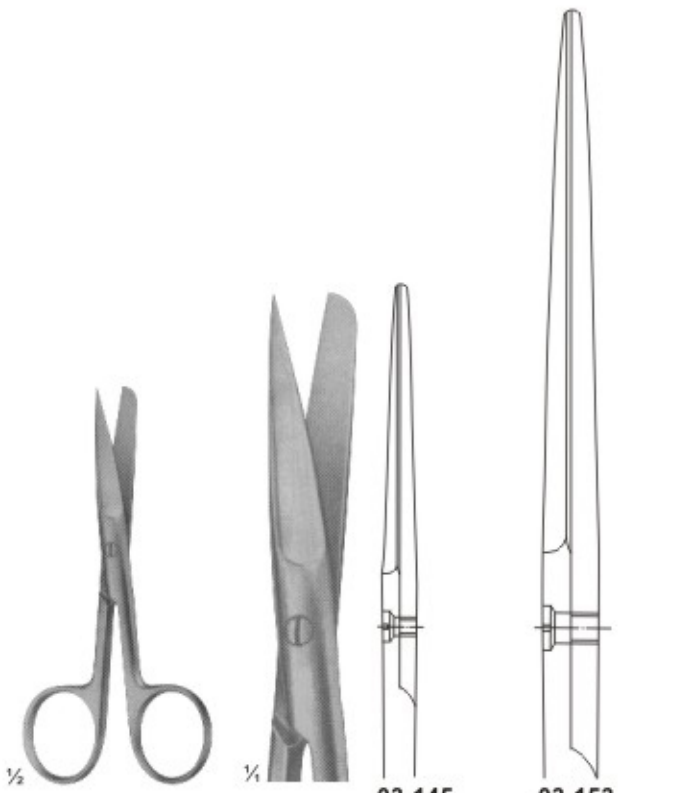

03-145 - 153 (Standard types)
03-145 (105 mm)
03-146 (115 mm)
03-147 (130 mm)
03-148 (145 mm)
03-149 (150 mm)
03-150 (165 mm)
03-151 (175 mm)
03-152 (185 mm)
03-153 (200 mm)



03-154 - 160 (Standard types)
03-154 (115 mm)
03-155 (130 mm)
03-156 (145 mm)
03-157 (150 mm)
03-158 (165 mm)
03-159 (175 mm)
03-160 (185 mm)

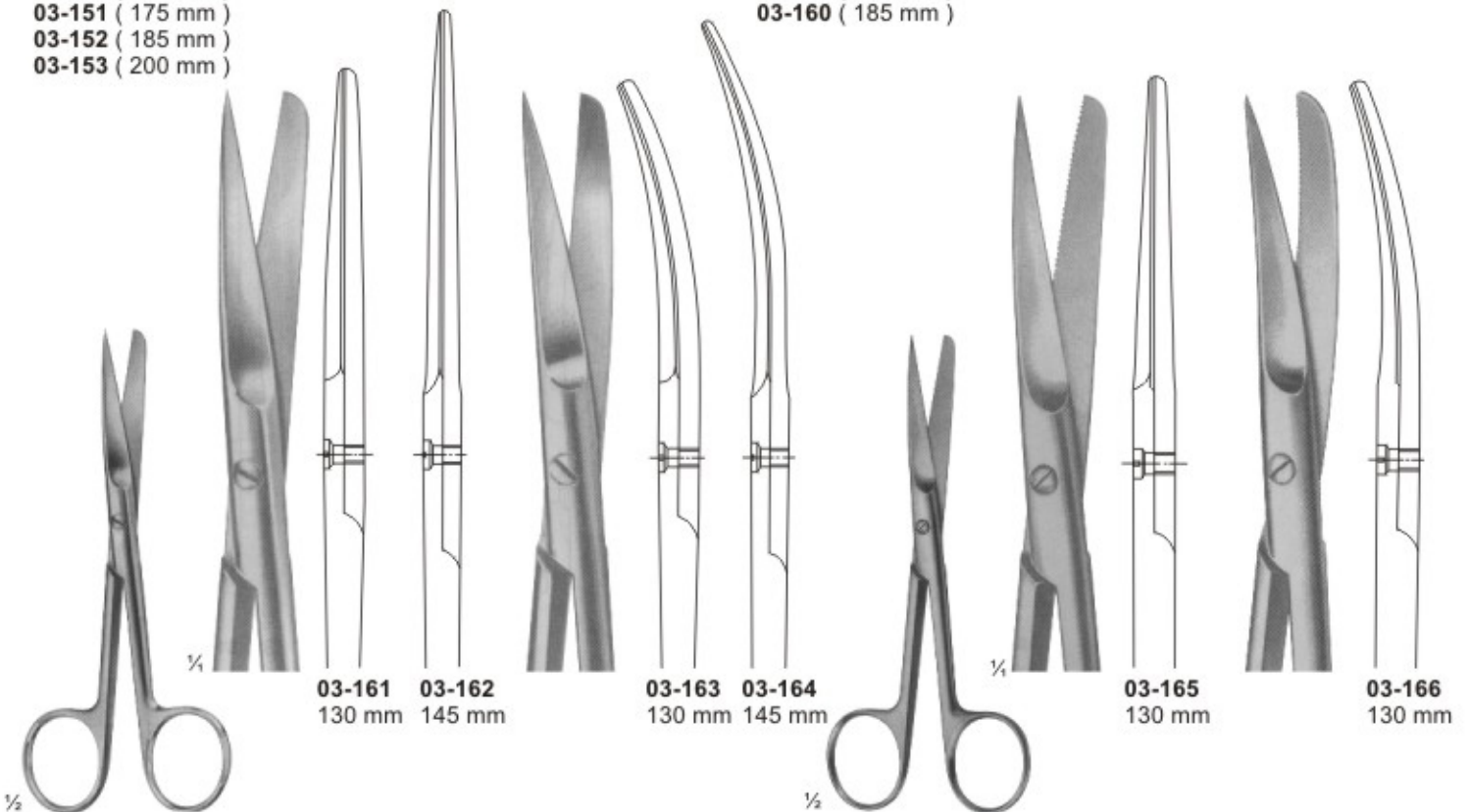

03-161 - 164
Slender types

03-165 - 166
for wound edges
1 blade serrated

Surgical Scissors
Chirurgische Scheren



03-167 - 169
DEAVER
with flat lock

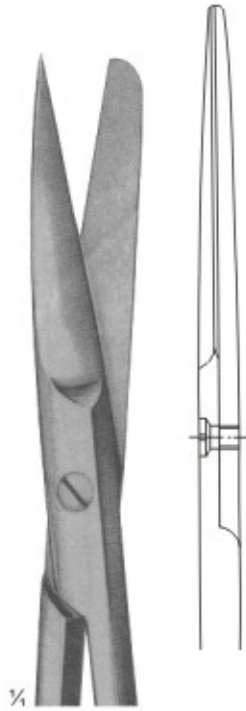

03-167
Size: 145 mm

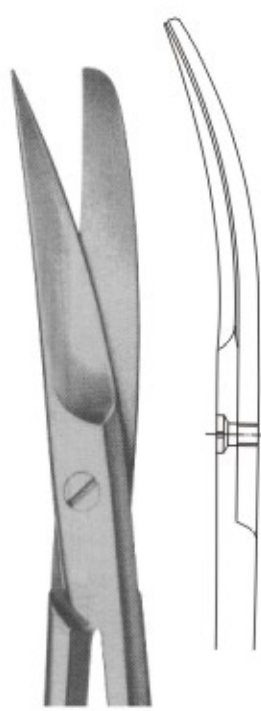

03-168
Size: 145 mm

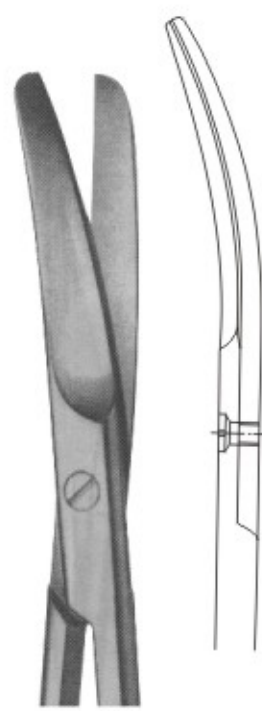

03-169
Size: 145 mm



03-170 - 172
Incision scissors

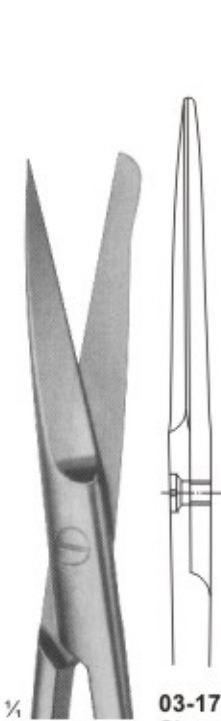

03-170
Size: 130 mm



03-171
Size: 145 mm

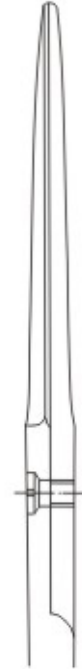

03-172
Size: 165 mm



03-173
SYSTRUNK
Nail splitting scissors

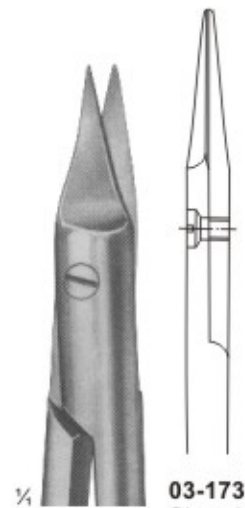

03-173
Size: 130 mm

Dissecting Scissors Praparierscheren

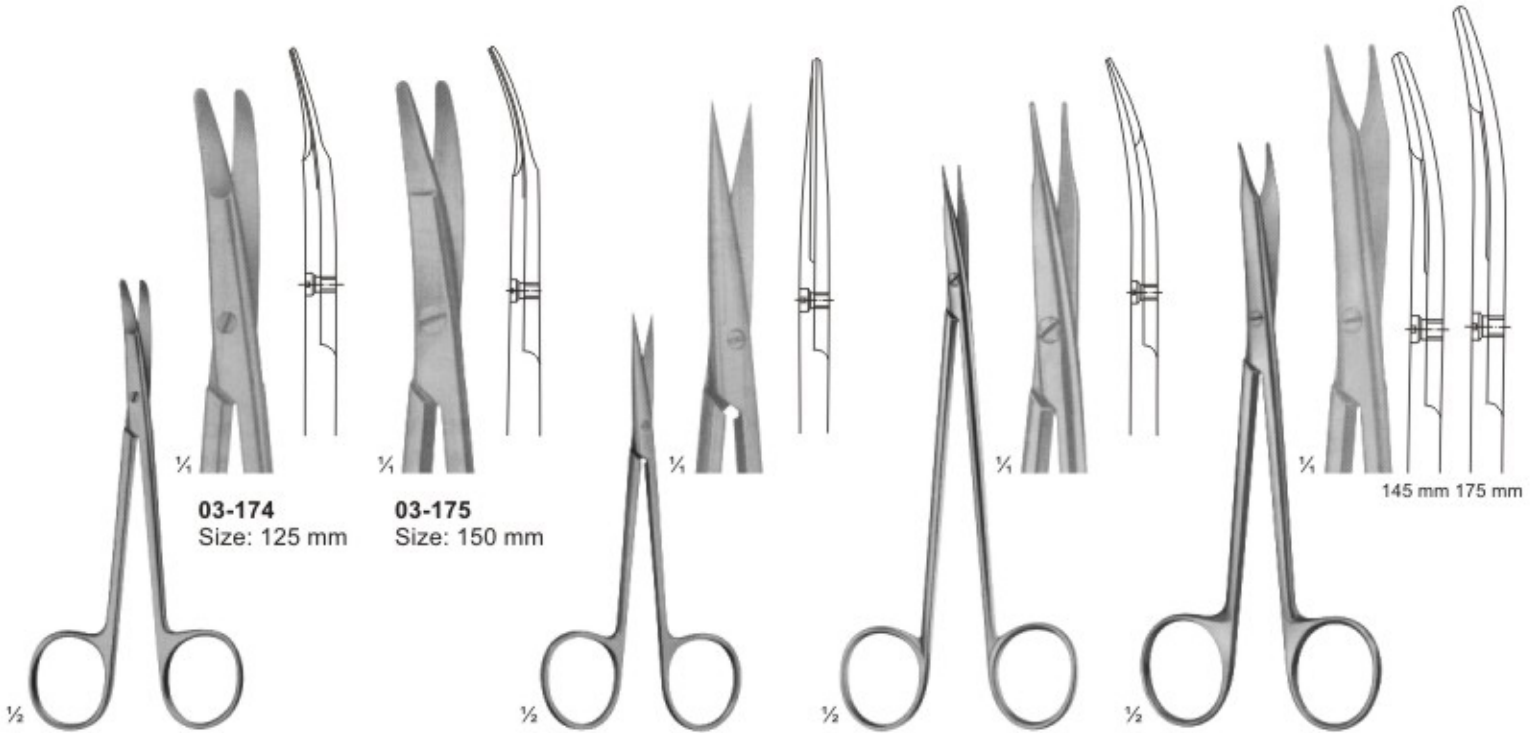

03-174 - 175
KILNER
Special flat points for dissecting
and undermining the skin

03-176
KILNER
Fine dissecting scissors
Size: 115 mm

03-177
JAMESON
Dissecting scissors
Size: 150 mm

03-178
REYNOLDS
Dissecting scissors
Size: 145 - 175 mm

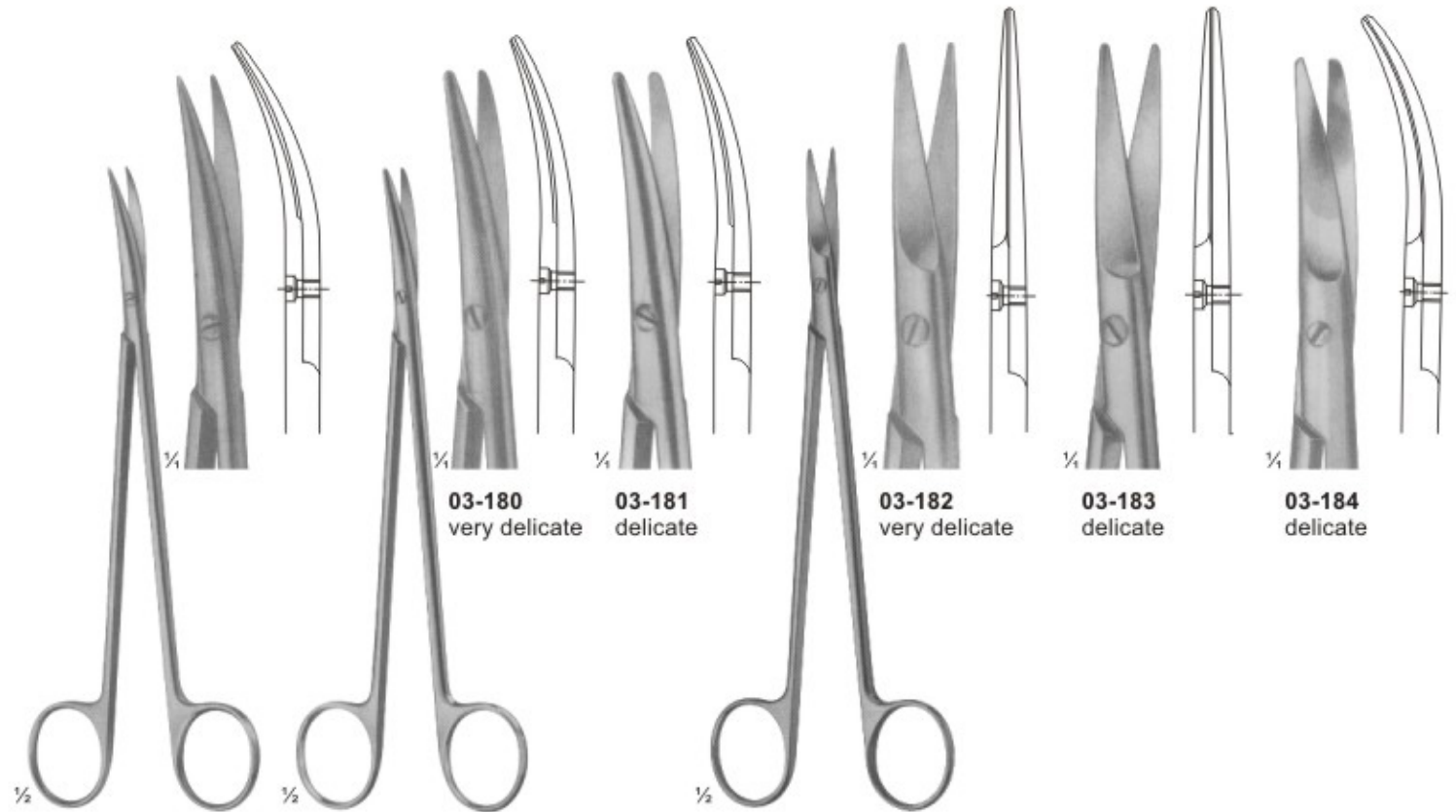

03-179
DE BAKEY
Arteriotomy scissors
Size: 175 mm

03-180 - 181
TOENNIS ADSON
Dissecting scissors
Size: 175 mm

03-182 - 184
TOENNIS
Dissecting scissors
Size: 180 mm

Dissecting Scissors Praparierscheren

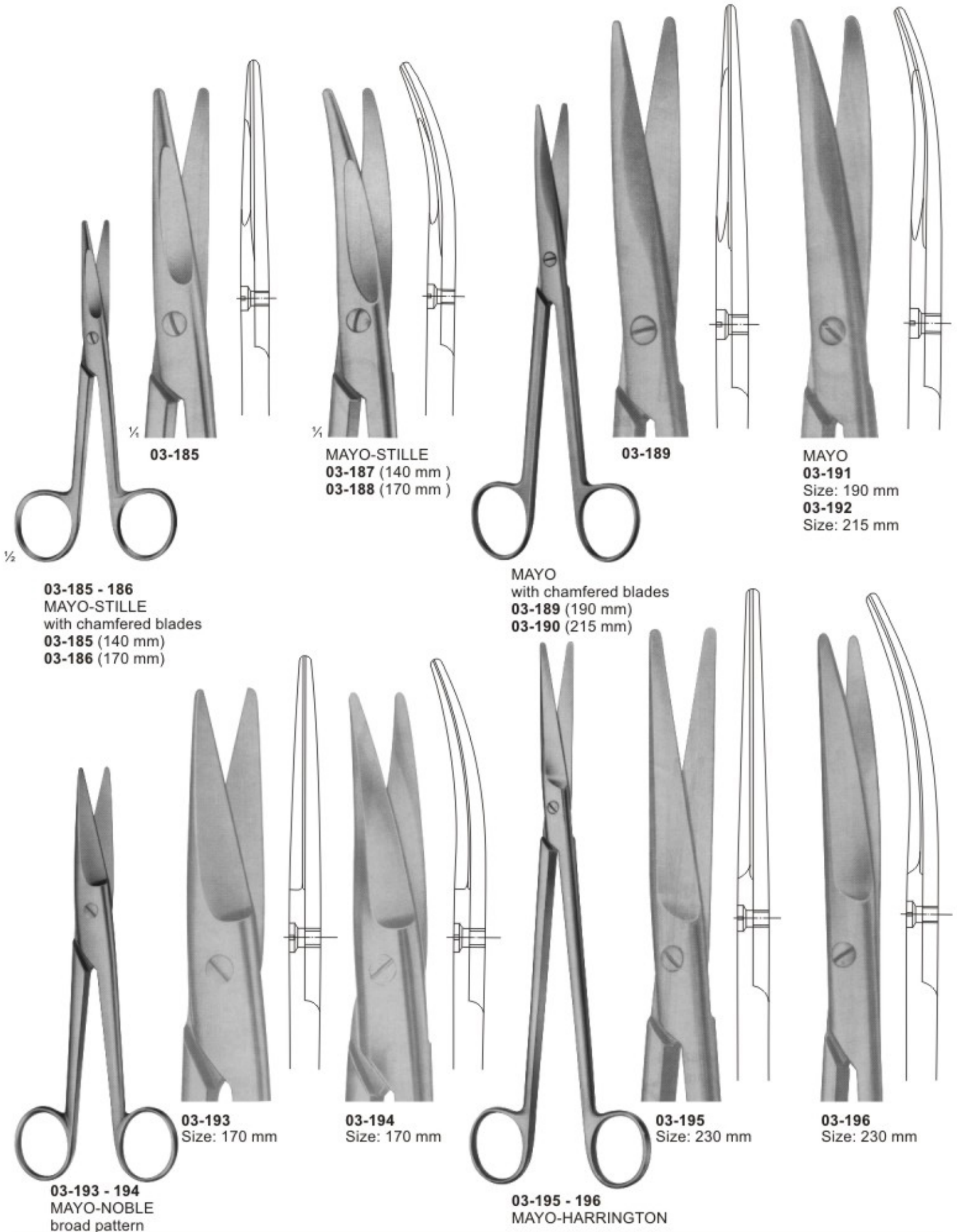

Scissors for Cardiovascular and Neuro-Surgery
Scheren für Herz-, Gefäß- und Neurochirurgie



03-207
OLIVECRONA
 Dura scissors

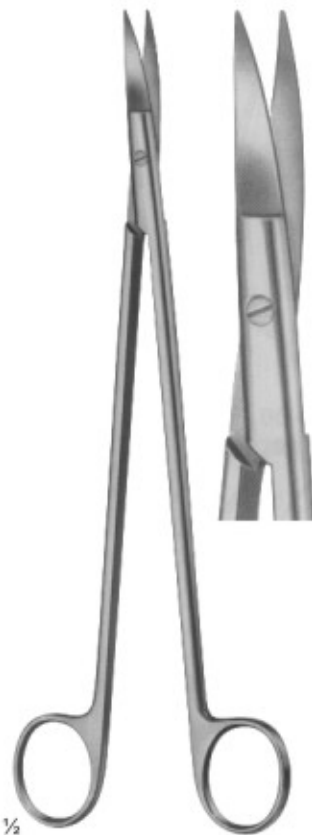

03-208
STRULLY
 pointed
 Size: 220 mm

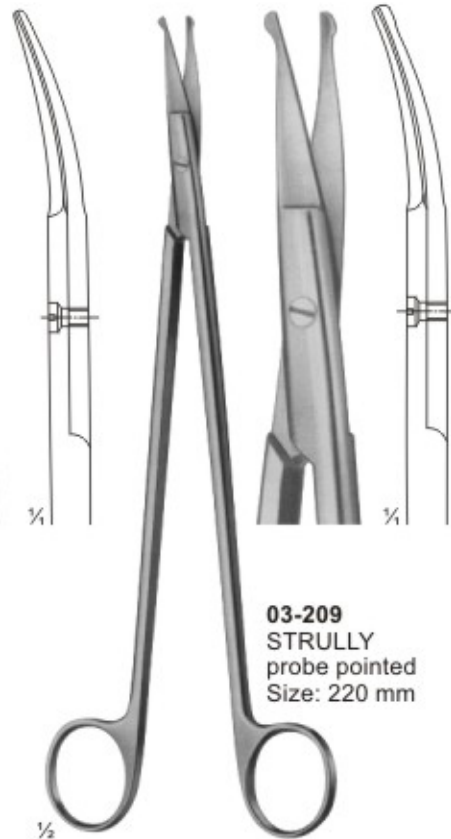

03-209
STRULLY
 probe pointed
 Size: 220 mm

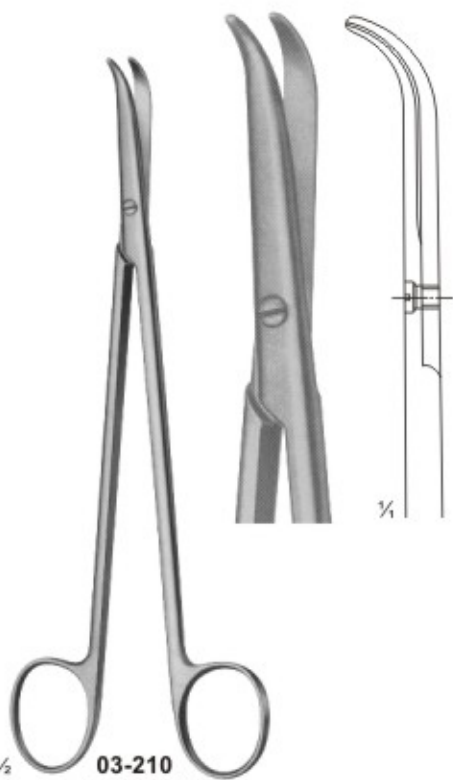

03-210
THOREK
 Size: 180 mm

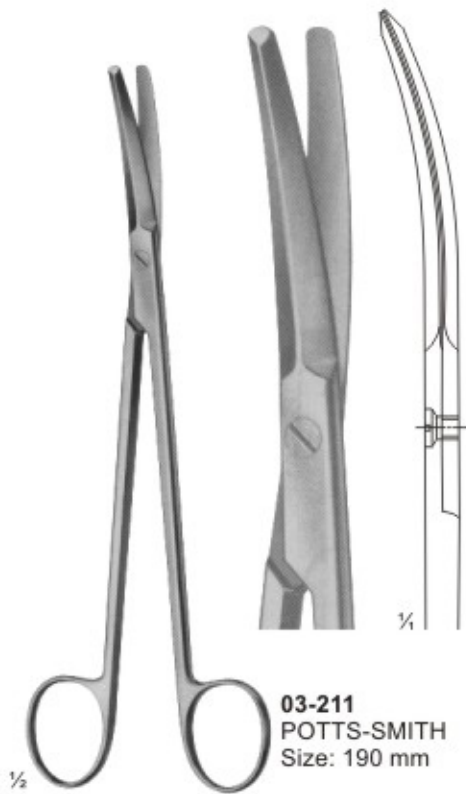

03-211
POTTS-SMITH
 Size: 190 mm

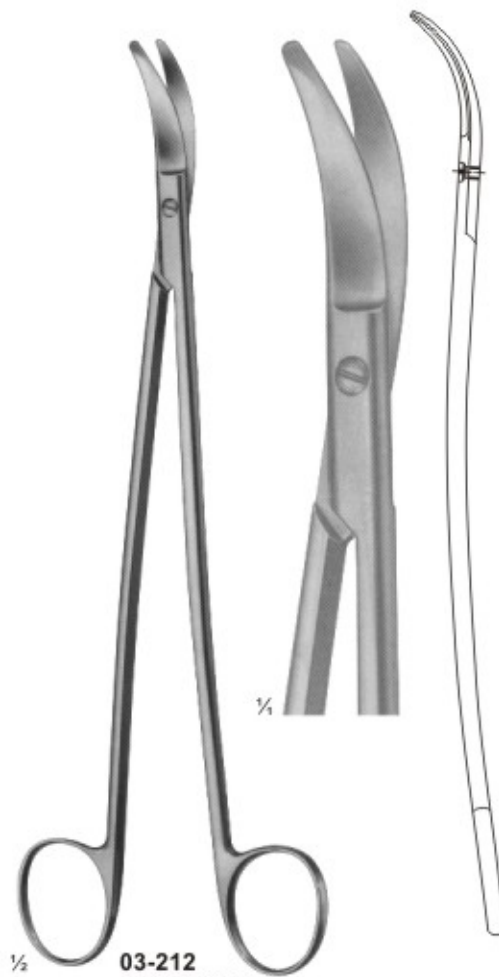

03-212
SATINSKY
 Size: 245 mm

Delicate, Nasal and Tonsil Scissors
Feine, Nasen und Tonsillenscheren

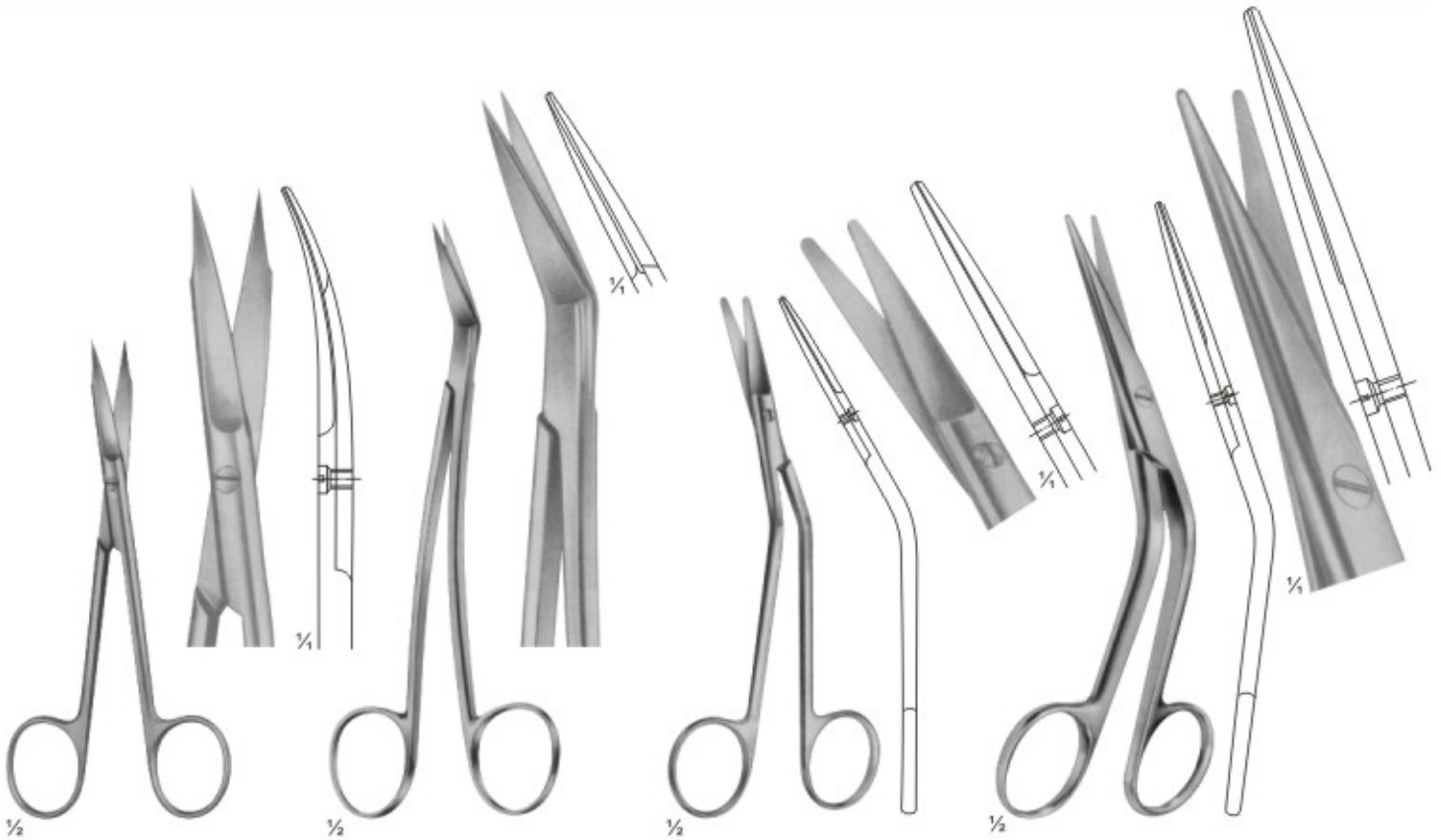

03-213
 1 finely toothed blade
 Size: 130 mm

03-214
 LOCKLIN
 curved sideways,
 1 toothed blade
 Size: 155 mm

03-215
 FOMON
 blades serrated
 Size: 145 mm

03-216
 COTTLE
 Size: 165 mm

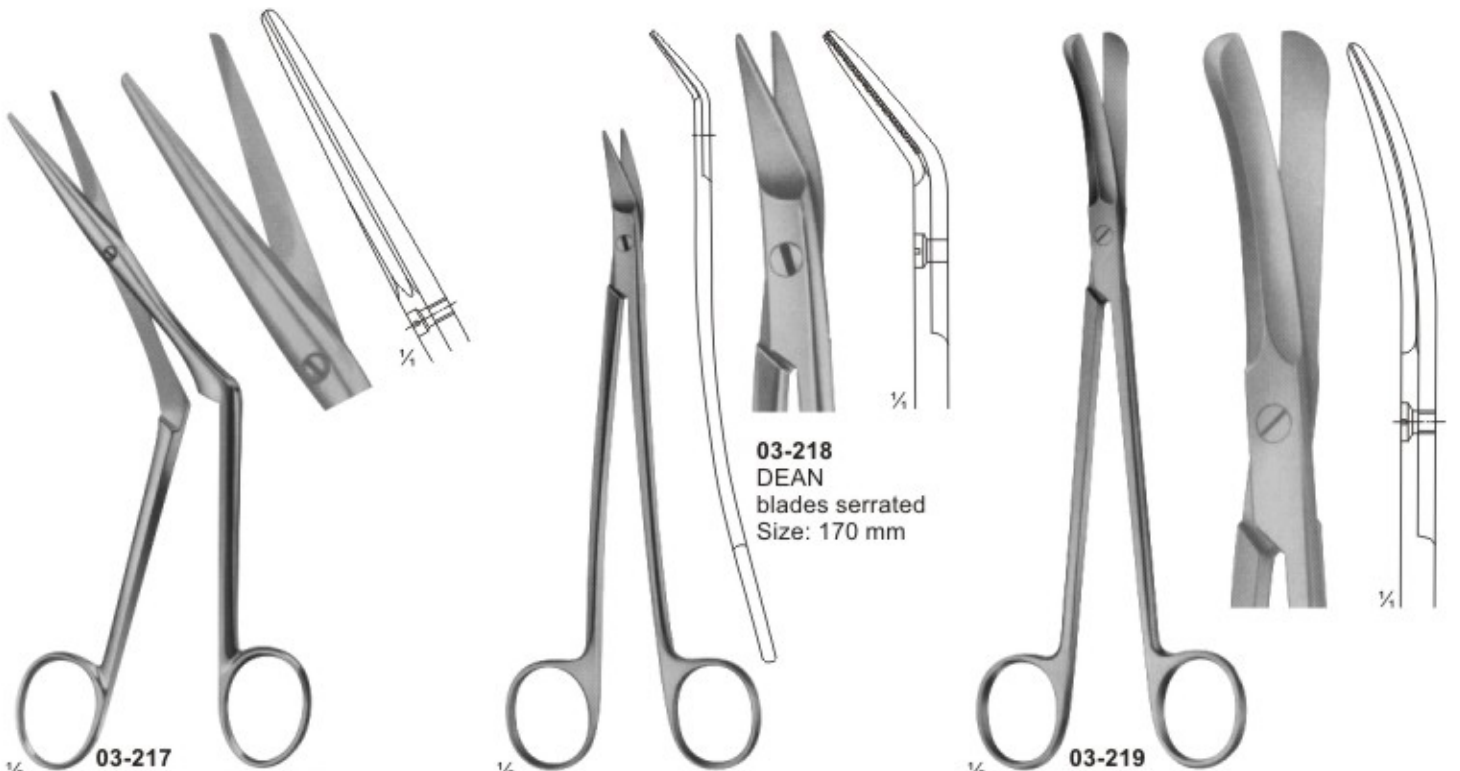

03-217
 HEYMANN-KNIGHT
 Size: 175 mm

03-218
 DEAN
 blades serrated
 Size: 170 mm

03-219
 GOOD
 Size: 195 mm

Bone Shears
Knochenscheren

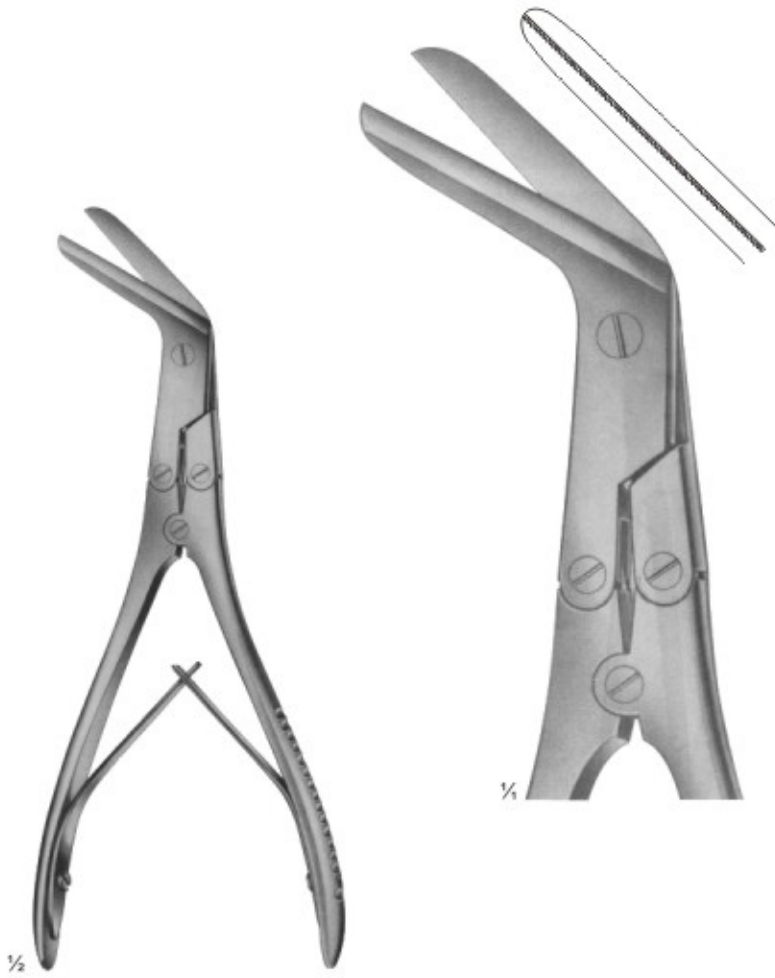

03-220
KILLIAN
Size: 200 mm



03-221 - 222

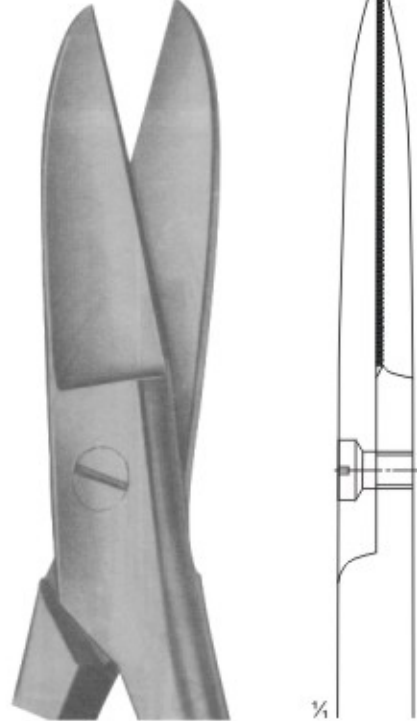

03-221
195 mm

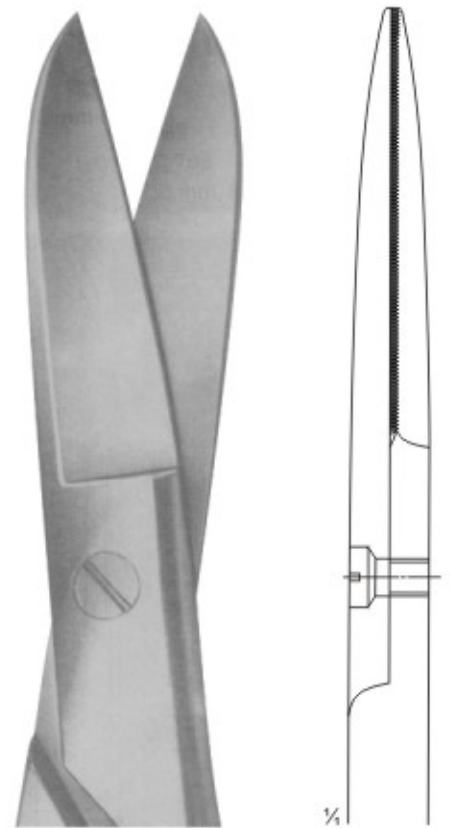

03-222
225 mm

Scissors for deep operations and for Gynaecology
Scheren für operationen in der Tiefe und für
Gynakologie

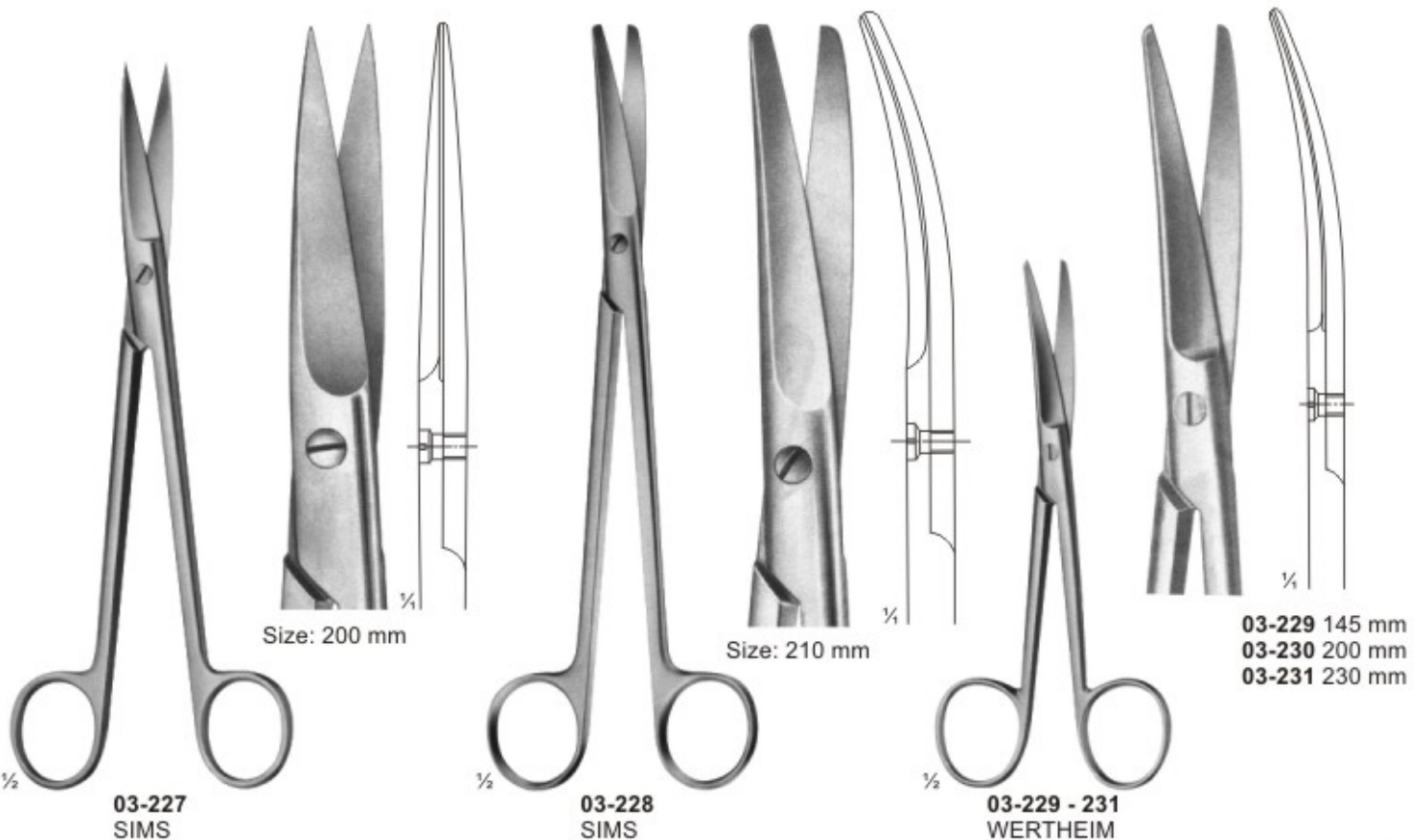
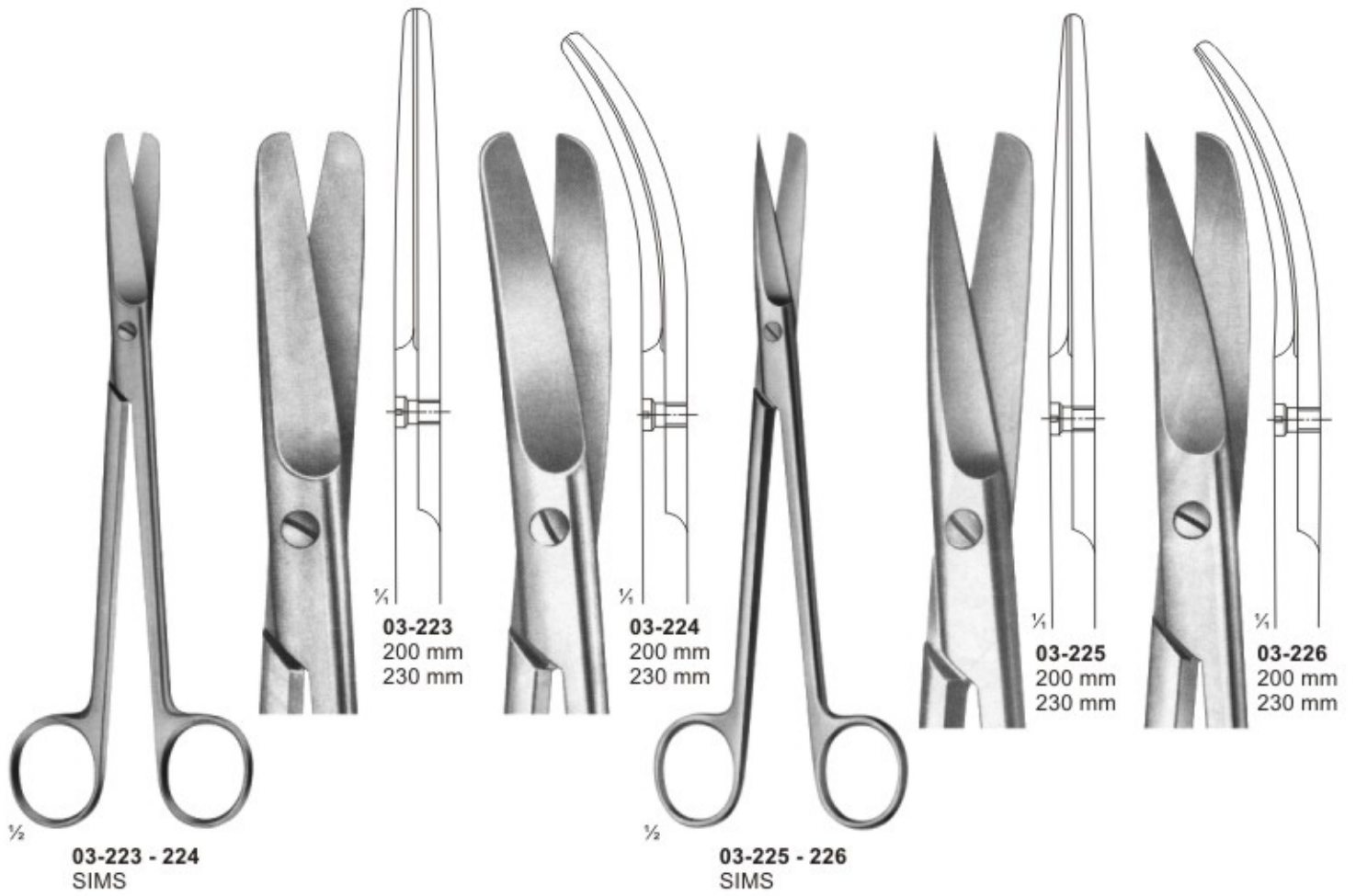



03-232
SCHUMACHER
 Umbilical cord scissors
 Size: 155 mm

03-233
 Umbilical cord scissors
 Size: 105 mm

03-234
 Umbilical cord scissors

135 mm



03-235 - 236
BRAUN-STADLER
 Episiotomy scissors

03-235
 145 mm

03-236
 200 mm

03-237
 Episiotomy scissors
 240 mm

Wire and Plate Scissors
Draht und Blechscheren



1/2

03-238 - 242
BEEBE
 Size: 110 mm

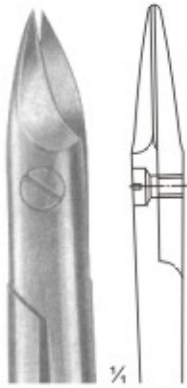

03-238

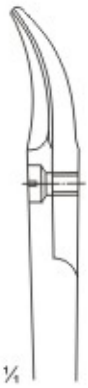

03-239

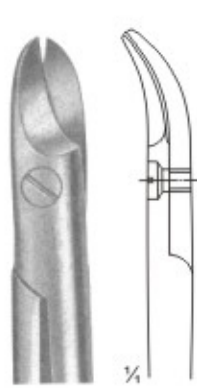

03-240
 broad blades

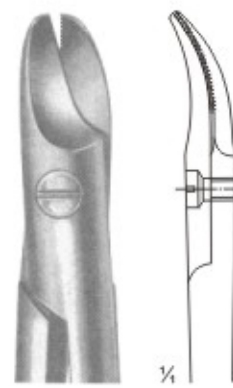

03-241
 1 blade serrated

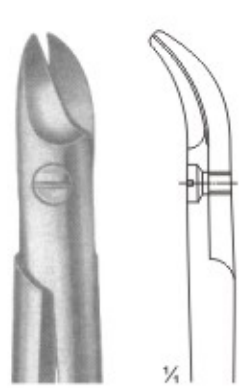

03-242
 NAUJOKS
 strongly curved

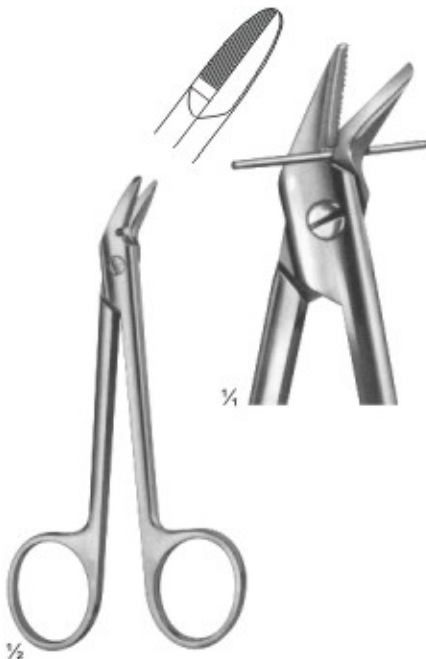

1/2

03-243
 1 blade serrated
 Size: 120 mm

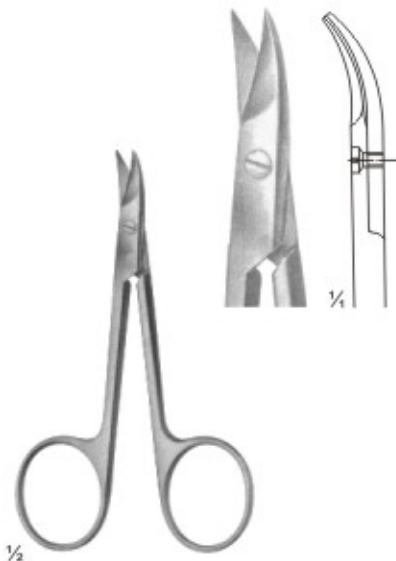

1/2

03-244
 STRACK
 Size: 100 mm

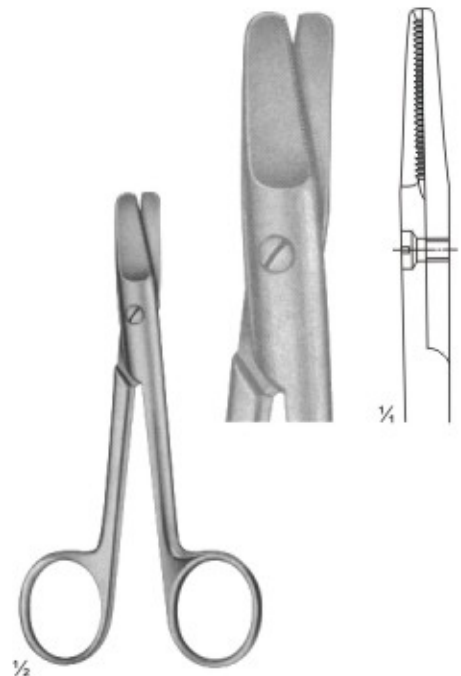

1/2

03-245
 HARVEY
 blades serrated
 Size: 125 mm



1/2
03-246
 Universal bandage and cloth scissors,
 with toothed edges
 180 mm

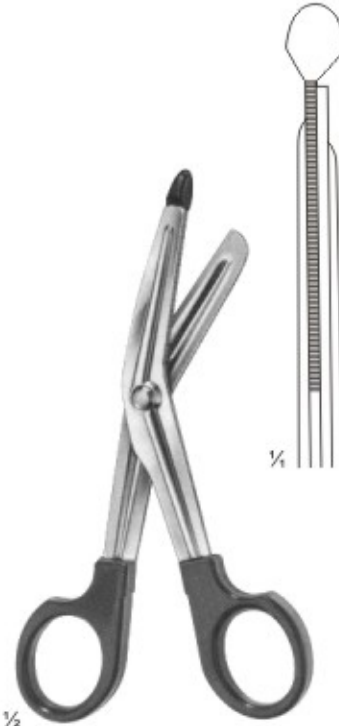

1/2
03-247
 LISTER
 Universal bandage and cloth scissors,
 with toothed edges
 Size: 145 mm

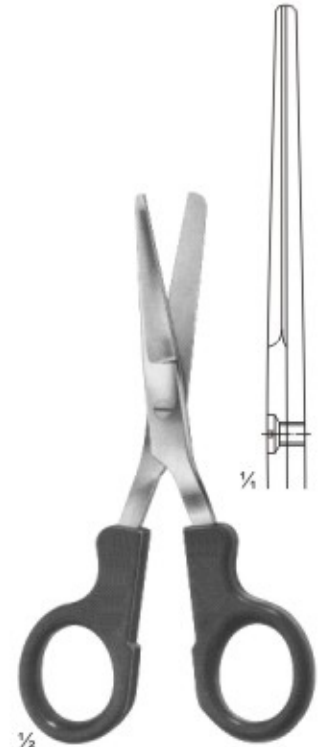

1/2
03-248
 LISTER
 Nurse's scissors
 Size: 145 mm

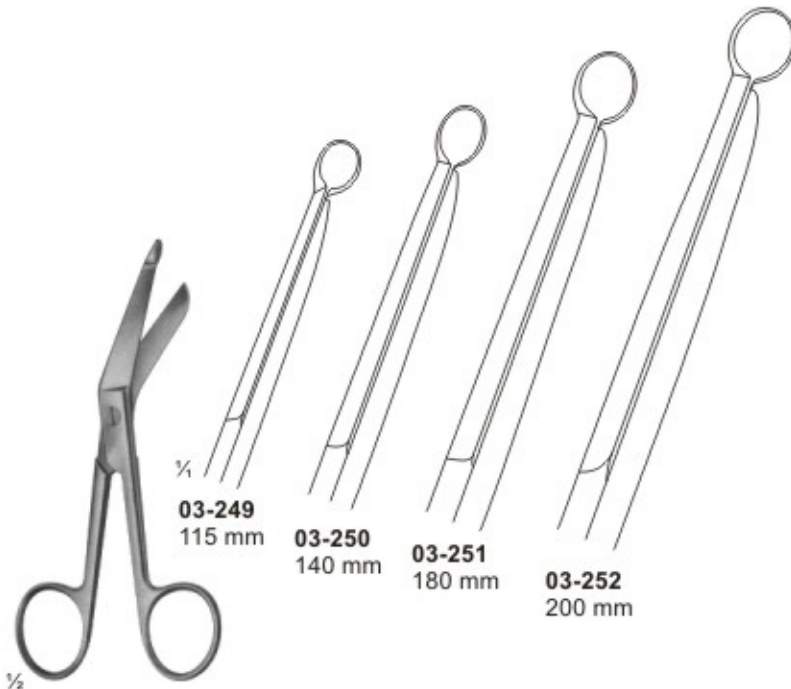

1/2
03-249 - 252
 LISTER

03-249
 115 mm

03-250
 140 mm

03-251
 180 mm

03-252
 200 mm

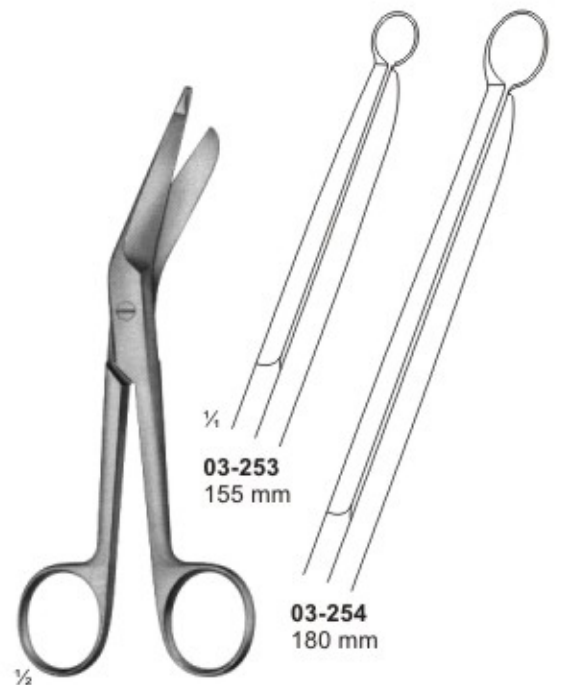

1/2
03-253 - 254
 LISTER

03-253
 155 mm

03-254
 180 mm

Bandage-, Cloth-, and Plaster Scissors
Verbands-, Kleider- und Gipsscheren



03-255
CLOTH SCISSORS
 205 mm

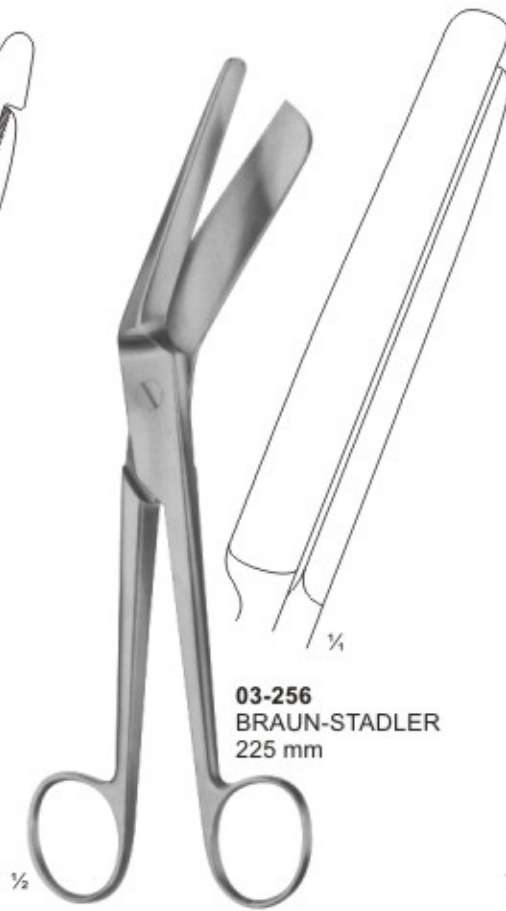

03-256
BRAUN-STADLER
 225 mm



03-257
SEUTIN
 230 mm



03-258 **03-259**
 200 mm 230 mm

03-258 - 259
ESMARCH

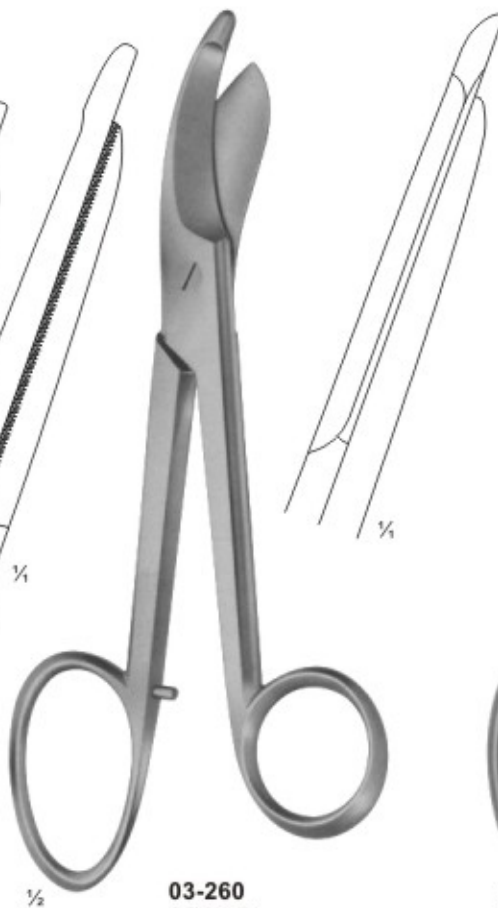

03-260
BRUNS
 235 mm

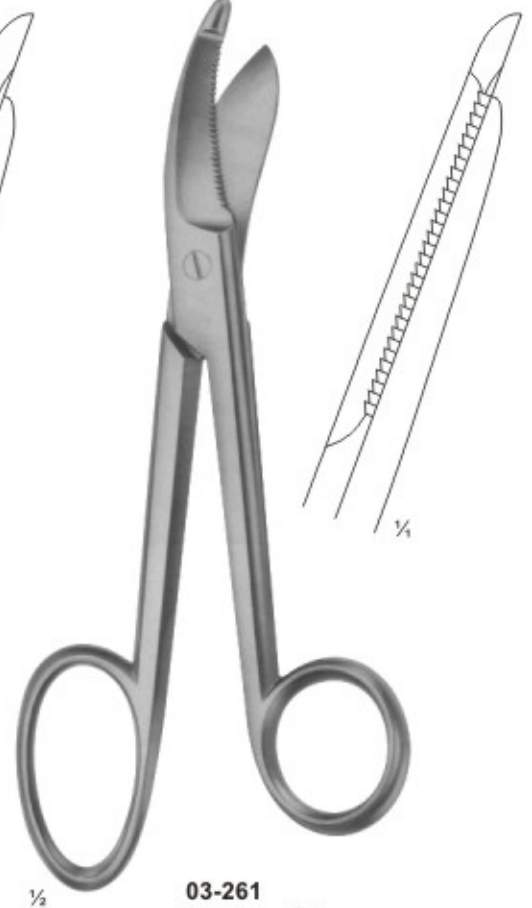

03-261
Bandage Scissors
 235 mm

**Forceps for grasping tissue, tumors etc.
Pinzetten zum Fassen von Gewebe Tumoren usw.**

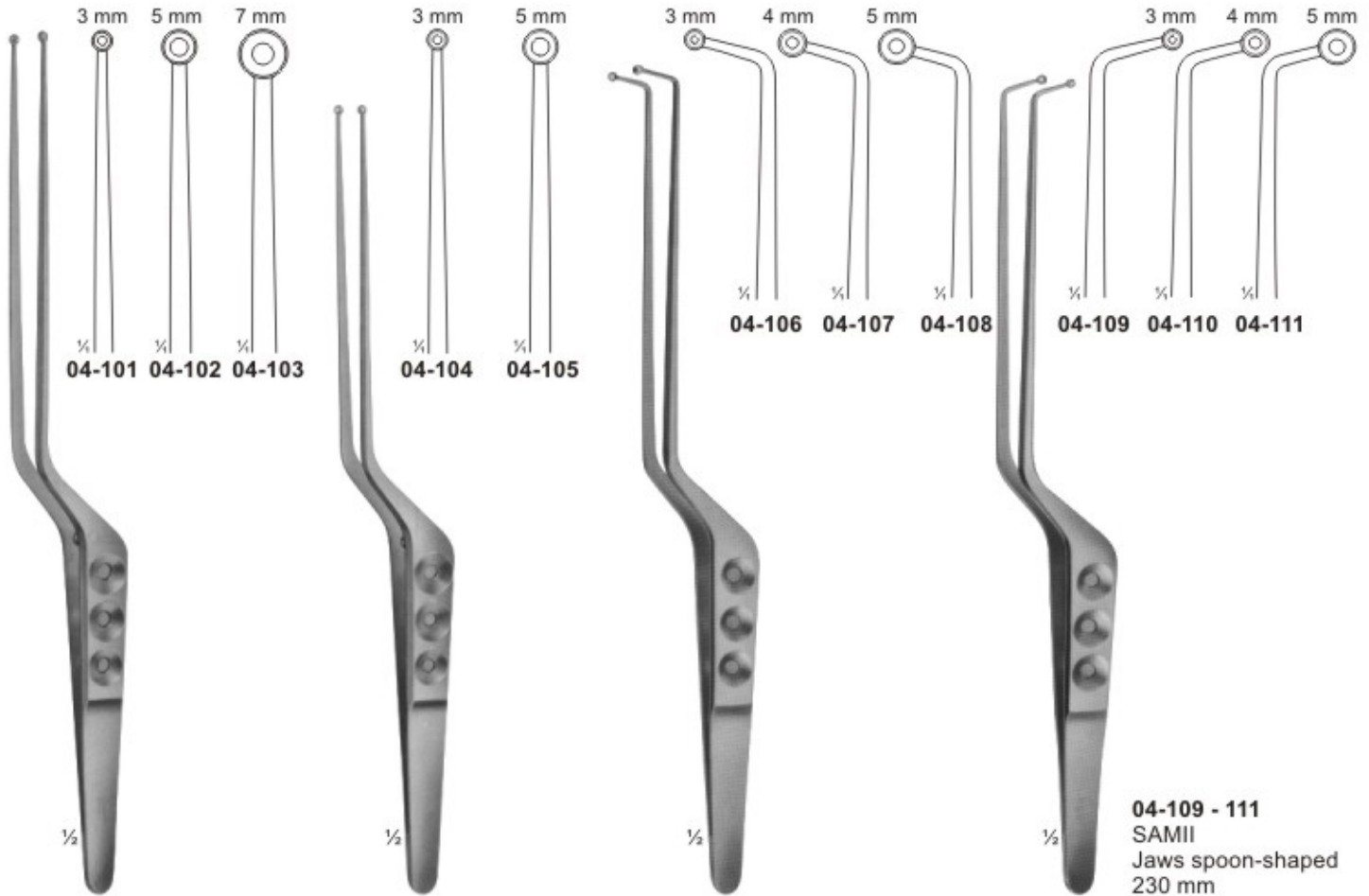

04-101 - 103
YASARGIL-SAMII
Jaws spoon-shaped
240 mm

04-104 - 105
YASARGIL
Jaws spoon-shaped
220 mm

04-106 - 108
SAMII
Jaws spoon-shaped
230 mm

04-109 - 111
SAMII
Jaws spoon-shaped
230 mm

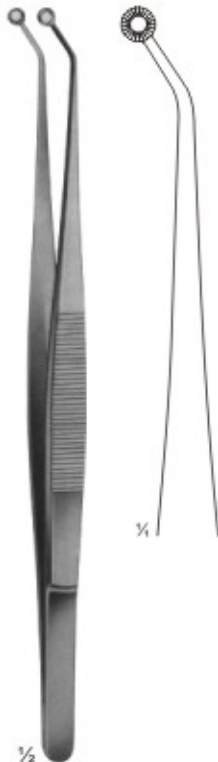

04-112
HUNT
Tumor and vessel forceps
200 mm

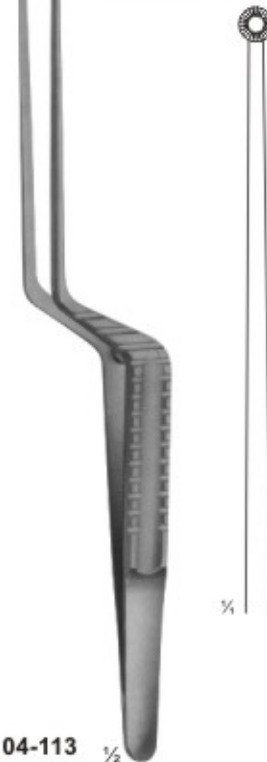

04-113
HUNT
Tumor and vessel forceps
200 mm



04-114
YASARGIL
Tumor and vessel forceps
200 mm

Delicate Dissecting, Microscopic, Sterilizing Forceps
Feine anatomische, Mikroskopier, Sterillisierpinzette



$\frac{1}{2}$
04-115
THORPE
 Corneal forceps
 120 mm

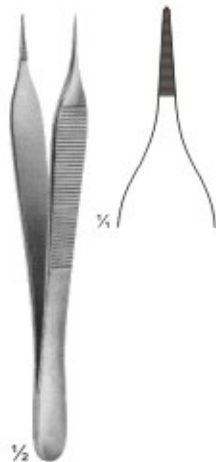

$\frac{1}{2}$
04-116
MICRO-ADSON
 120 mm

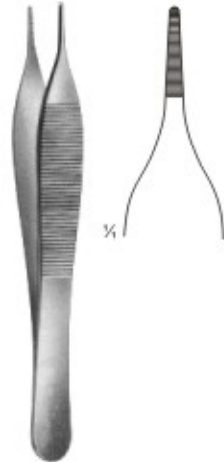

$\frac{1}{2}$
04-117
ADSON
 120 mm



$\frac{1}{2}$
04-118
MICRO-ADSON
 150 mm



$\frac{1}{2}$
04-119 - 121
 100 mm



$\frac{1}{2}$
04-119



$\frac{1}{2}$
04-120



$\frac{1}{2}$
04-121

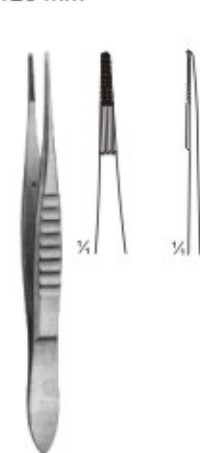

$\frac{1}{2}$
04-122
BONACCOLTO
 110 mm

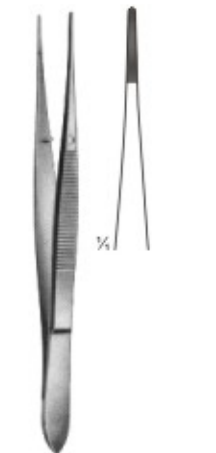

$\frac{1}{2}$
04-123
 115 mm

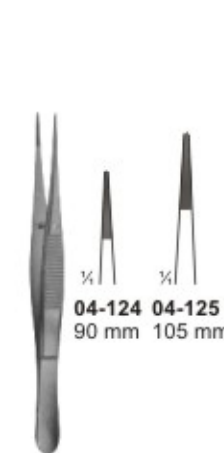

$\frac{1}{2}$
04-124 - 133

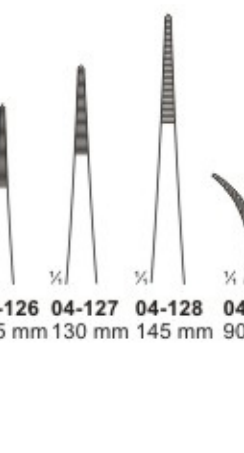

$\frac{1}{2}$
04-124 90 mm **04-125** 105 mm **04-126** 115 mm **04-127** 130 mm **04-128** 145 mm **04-129** 90 mm



$\frac{1}{2}$
04-130 105 mm



$\frac{1}{2}$
04-131 115 mm



$\frac{1}{2}$
04-132 130 mm



$\frac{1}{2}$
04-133 145 mm

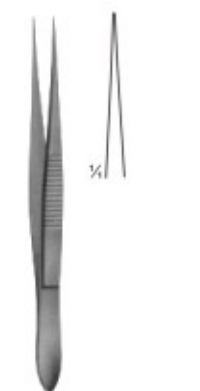

$\frac{1}{2}$
04-134
 100 mm

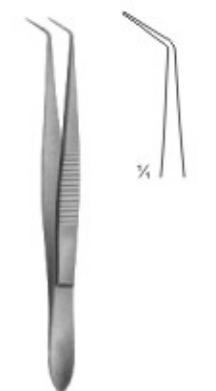

$\frac{1}{2}$
04-135
 100 mm

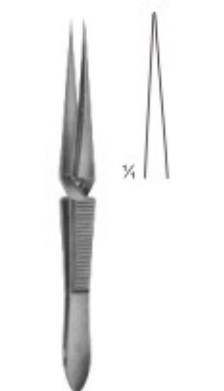

$\frac{1}{2}$
04-136
 100 mm

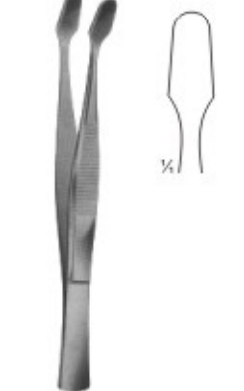

$\frac{1}{2}$
04-137
KUHNE
 Cover glass forceps, 105 mm



$\frac{1}{2}$
04-138
 160 mm

Delicate Dissecting Forceps
Feine anatomische Pinzetten

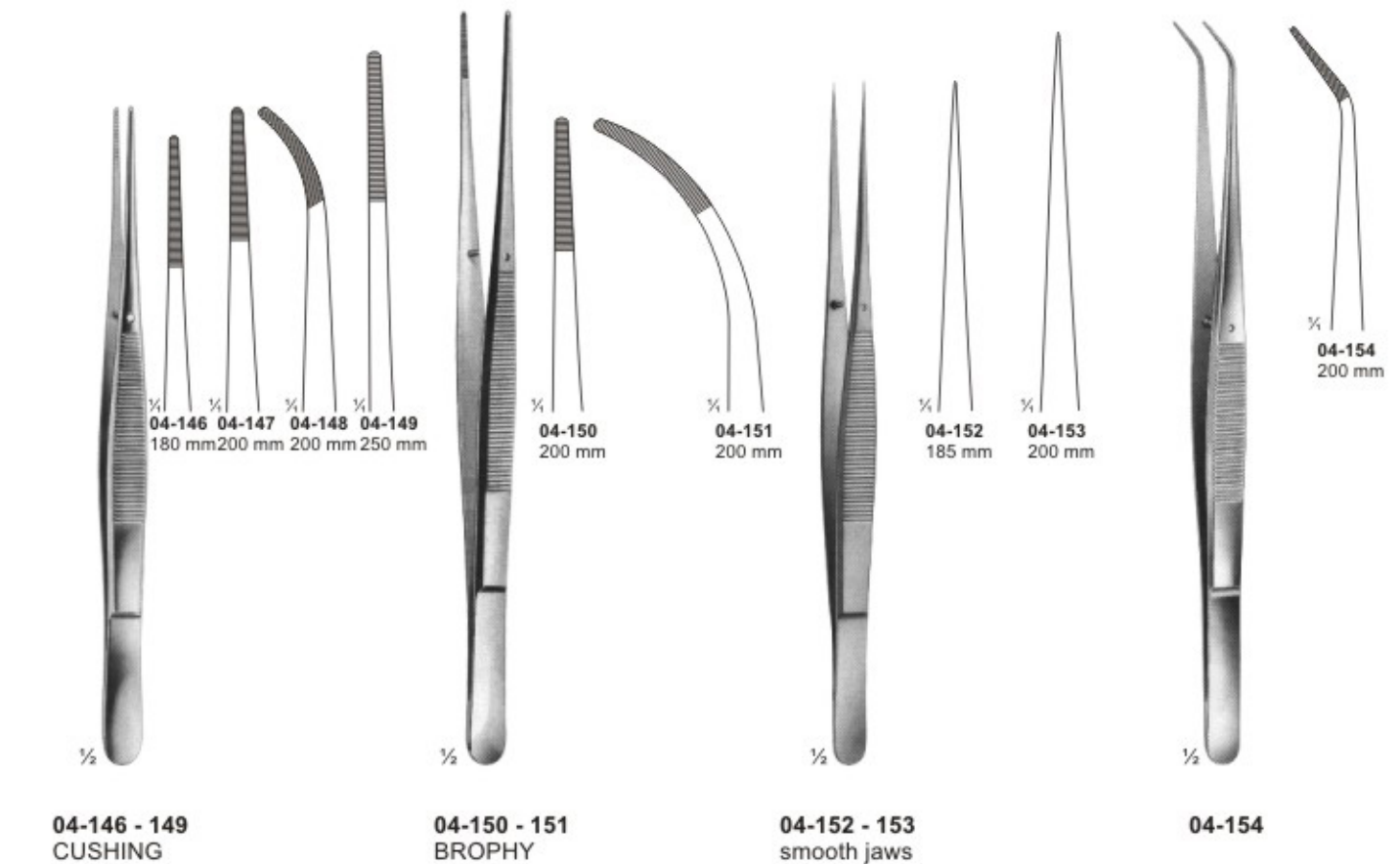
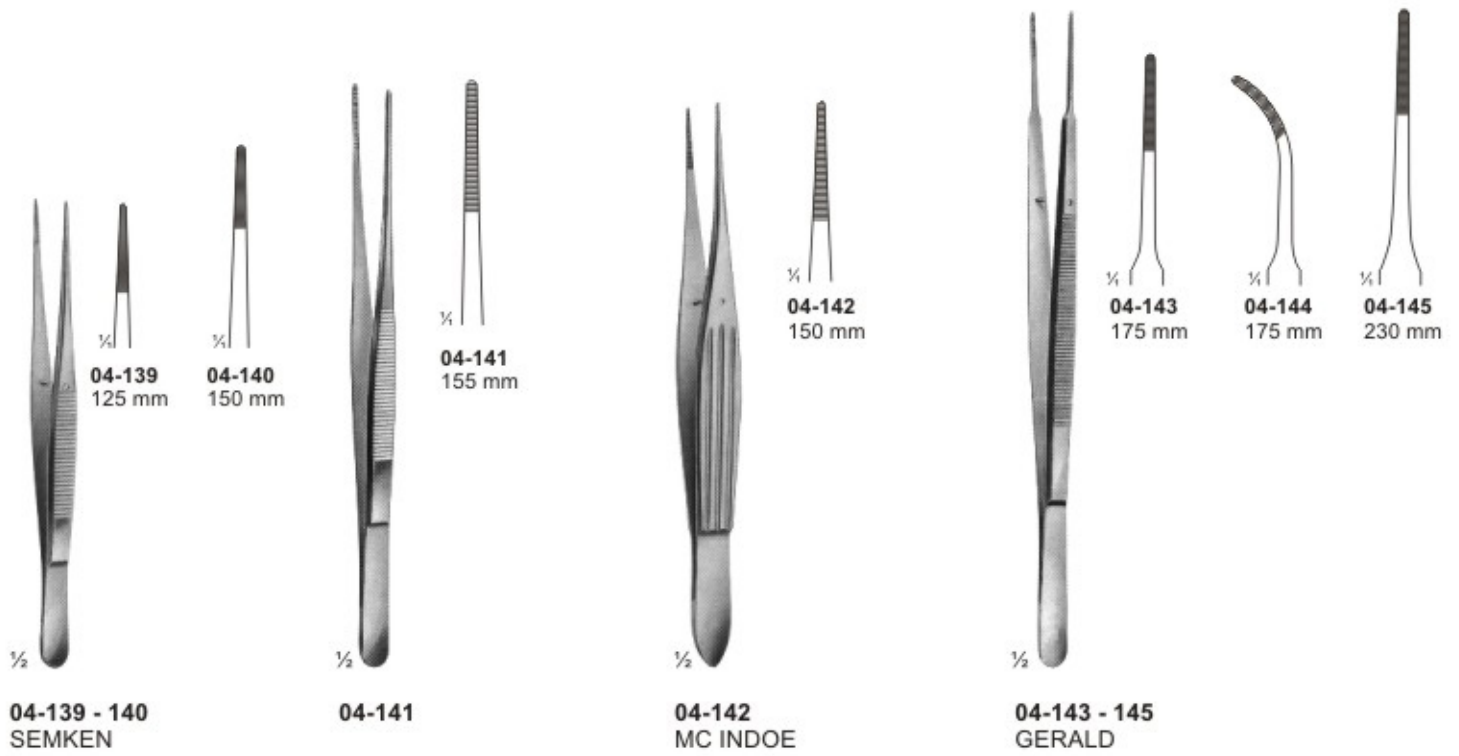

Forceps Pinzetten

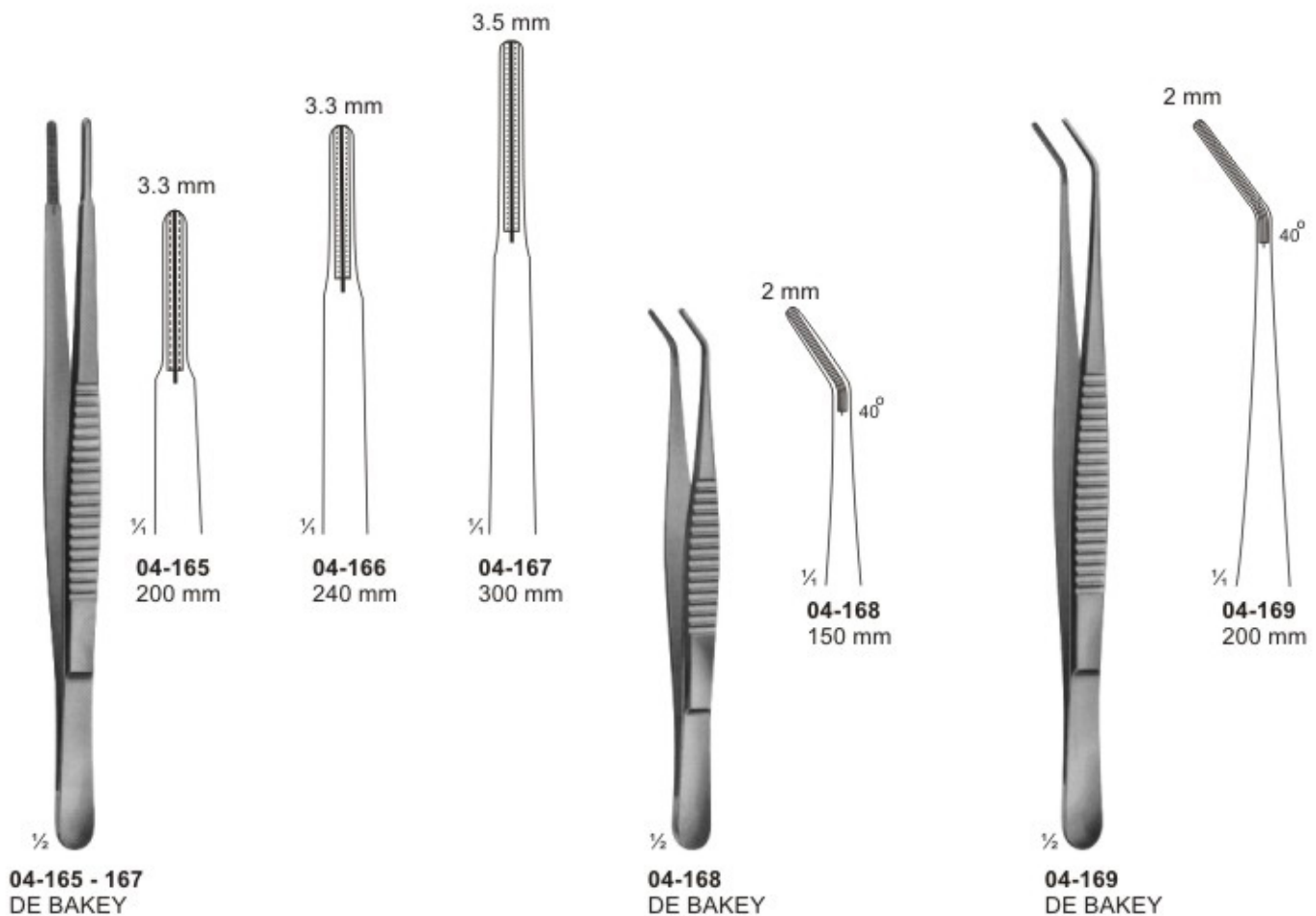
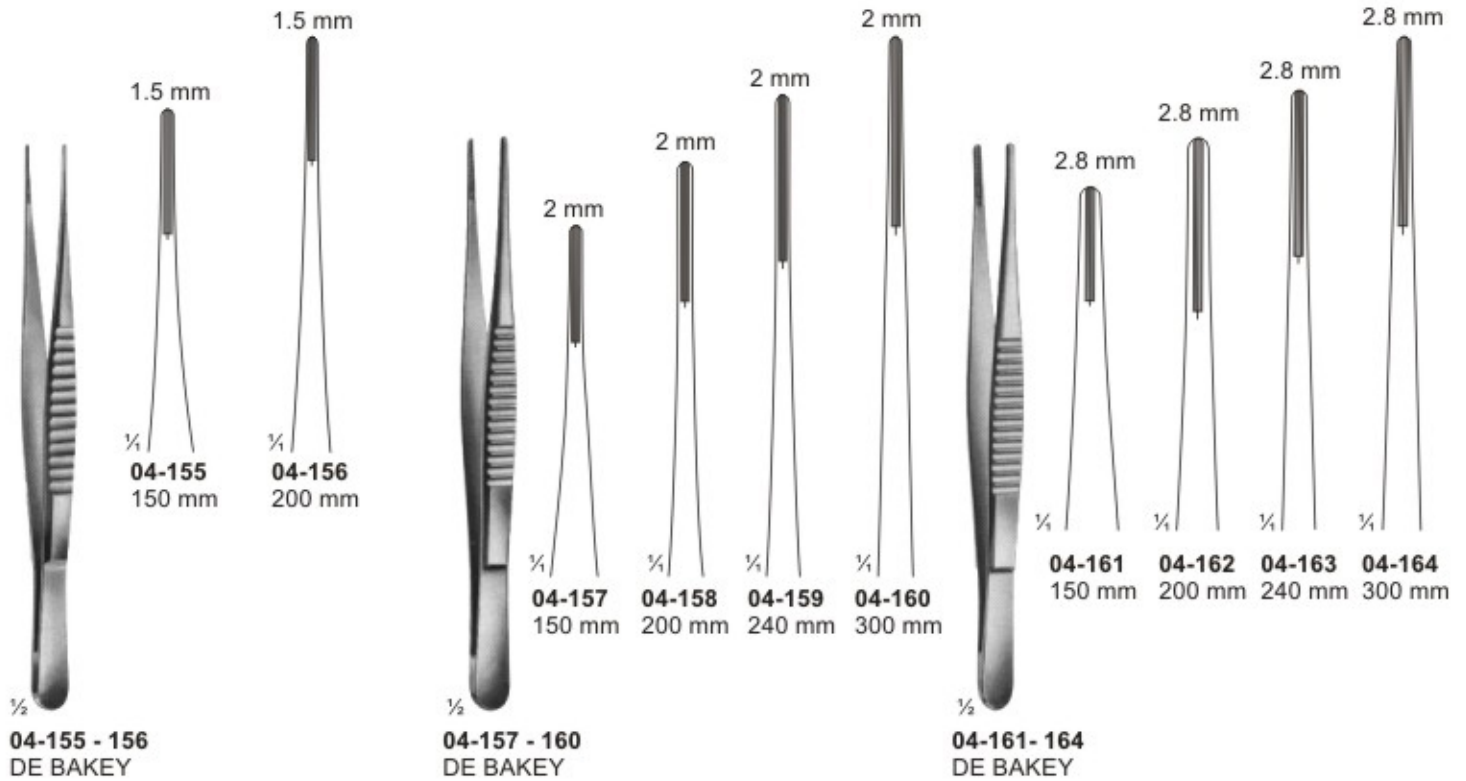

Delicate Tissue Forceps Feine chirurgische Pinzetten



04-170
BISHOP-HARMON
85 mm

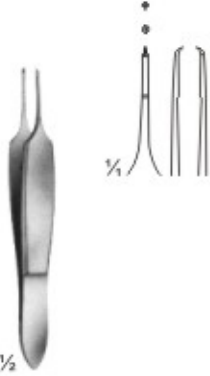

04-171
ST.MARTIN
80 mm

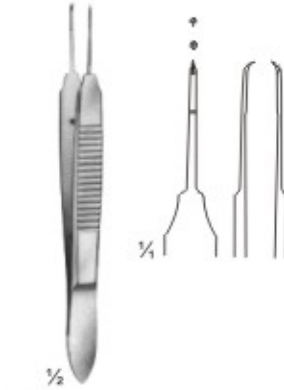

04-172
CASTROVIEJO
teeth 0.9 mm
100 mm



04-173
CASTROVIEJO
teeth 0.5 mm
100 mm

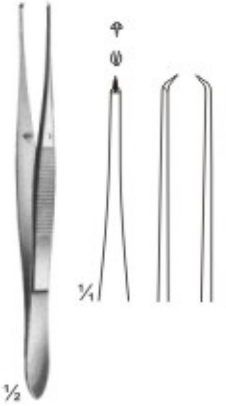

04-174
ELSCHING
110 mm



04-175
GILL
75 mm



04-176
GILL - HESS
75 mm

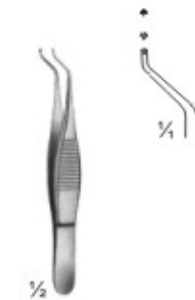

04-177
HESS
70 mm

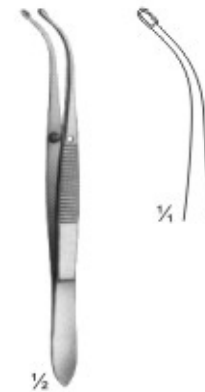

04-178
ARRUGA
100 mm

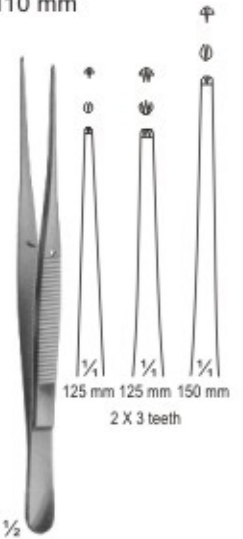

04-179
SEMKEN
125 mm 125 mm 150 mm
2 X 3 teeth



04-180
MICRO-ADSON
120 mm

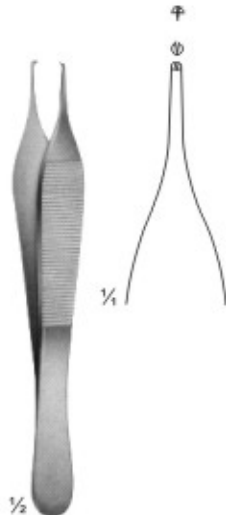

04-181
ADSON
120 mm



04-182
ADSON
120 mm



04-183
ADSON
120 mm

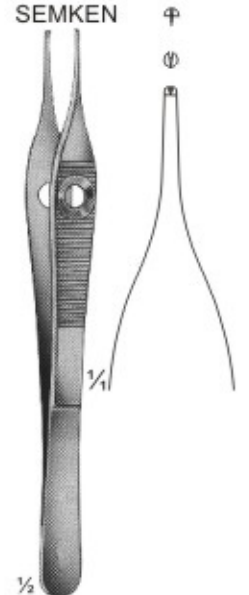

04-184
ADSON
150 mm

Tissue Forceps, Lung Dissecting Forceps Chirurgische Pinzetten, Lungenfaßpinzetten

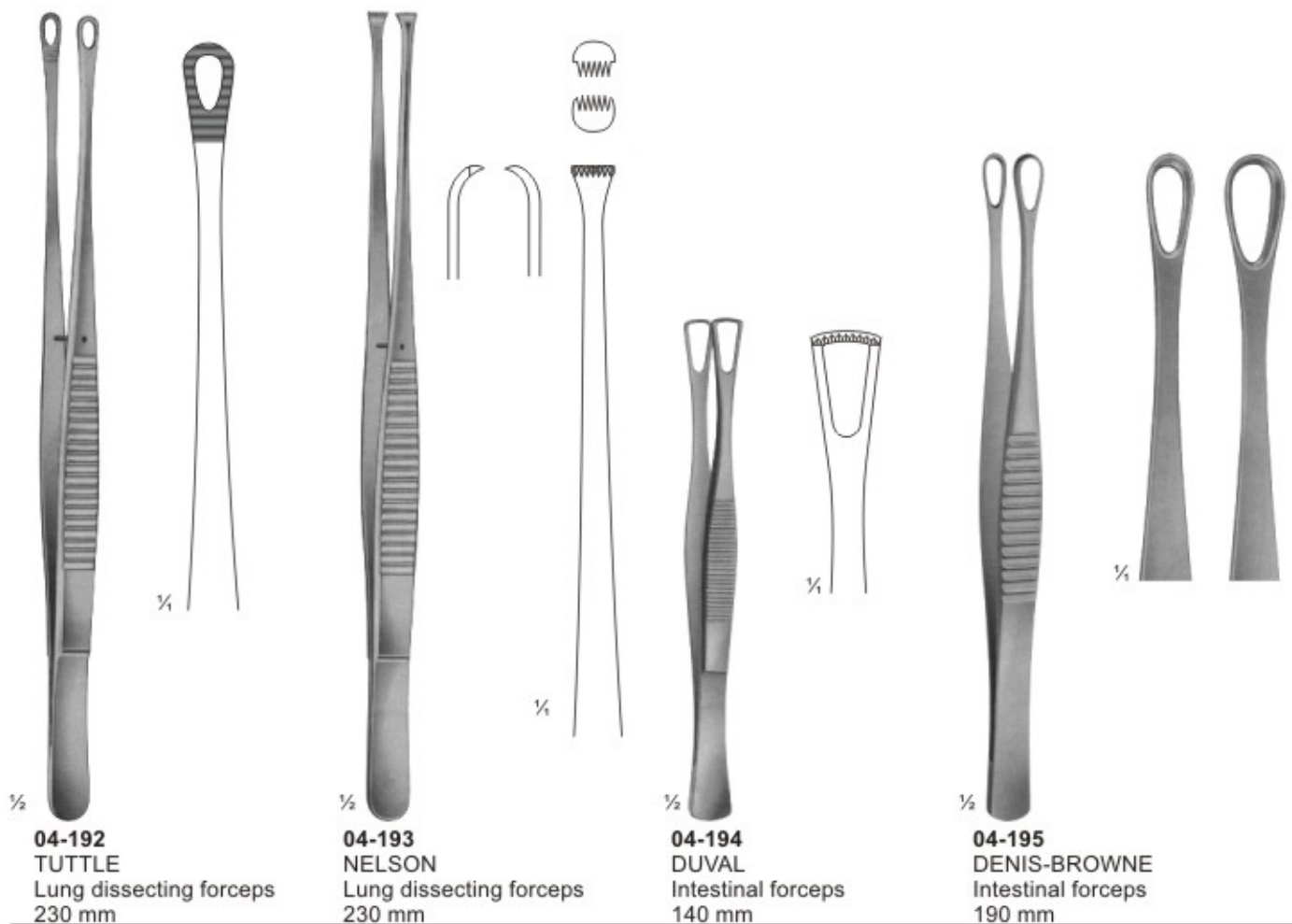
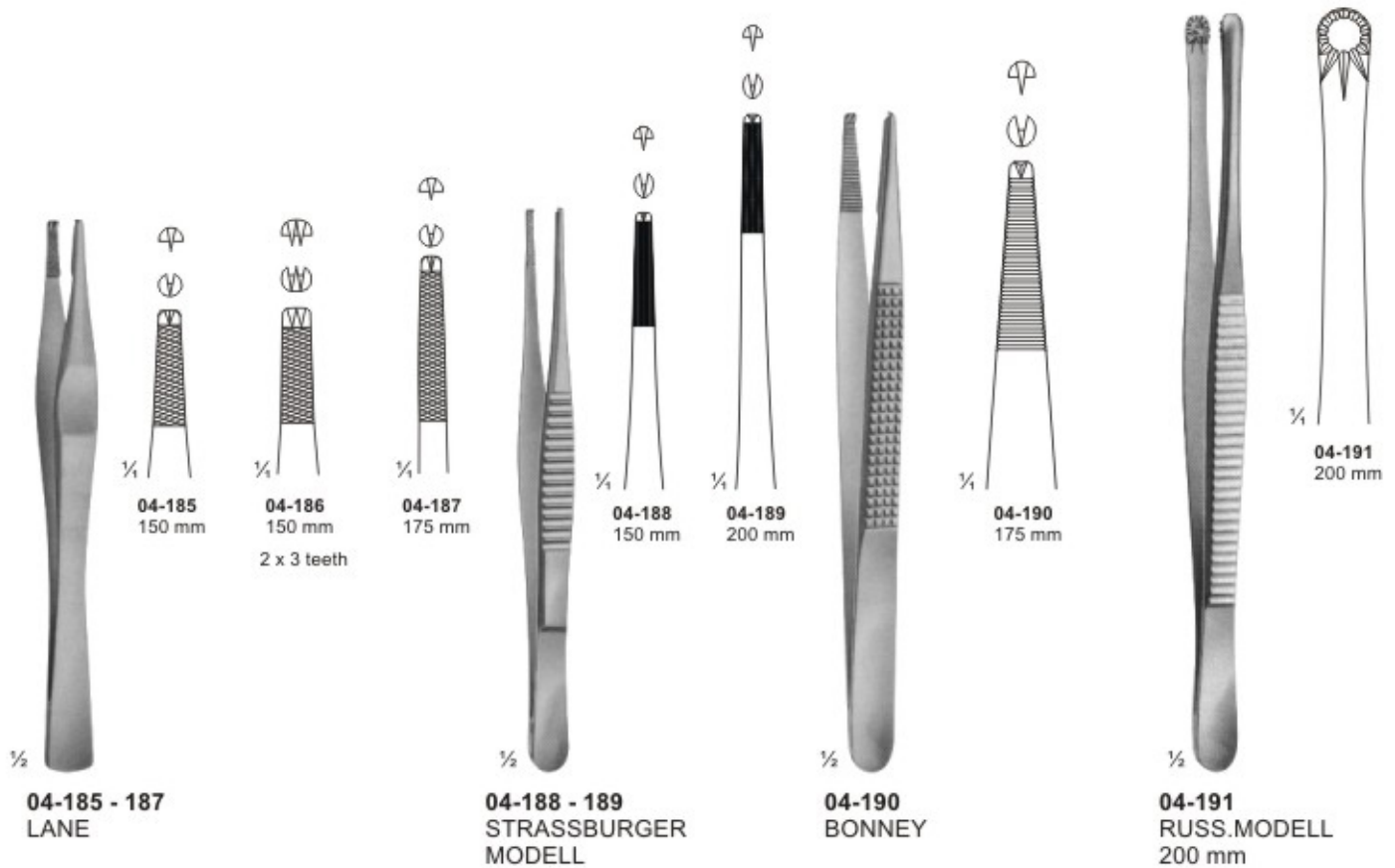

Splinter and Cilia Forceps Splitter und Clienpinzetten

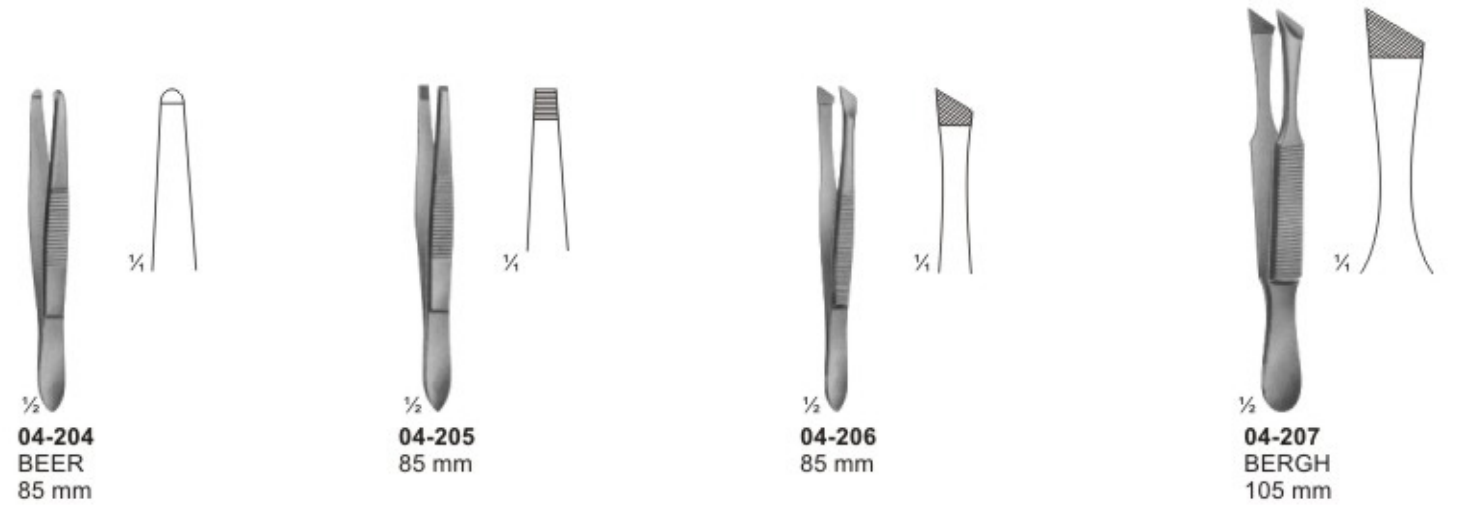
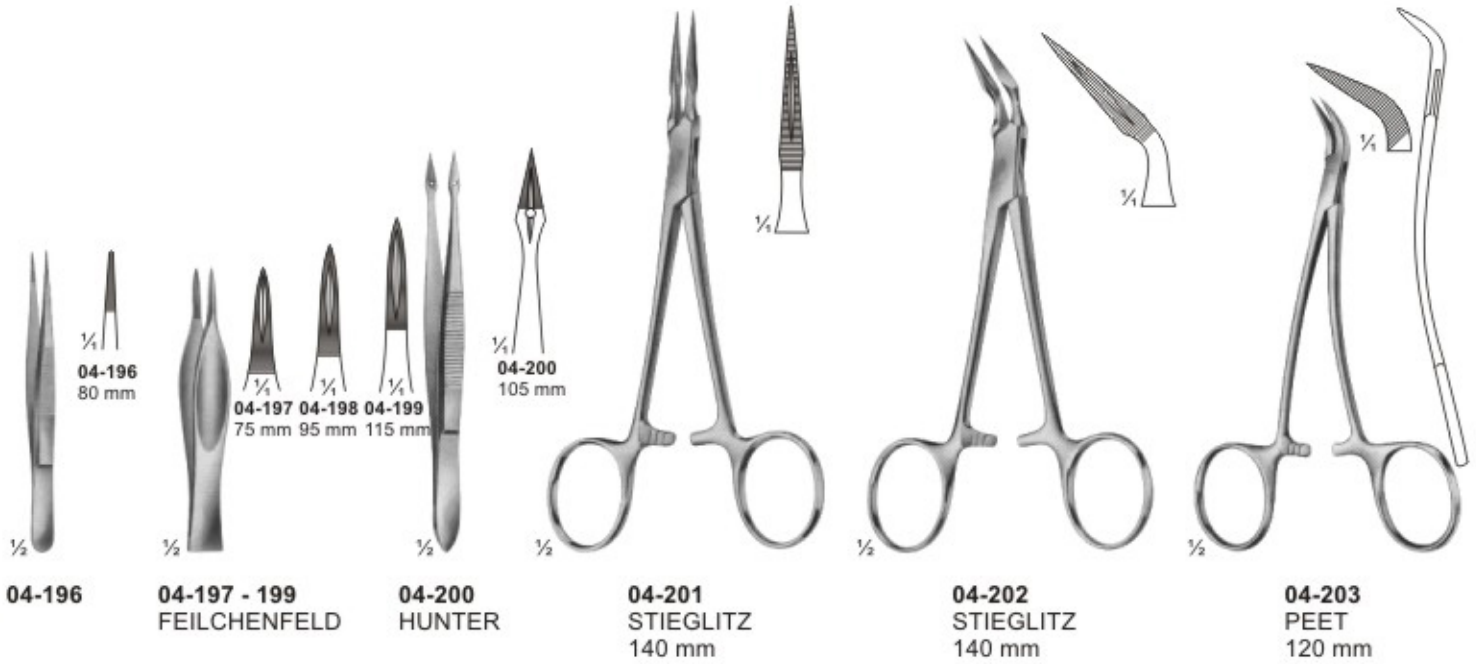

Sponge and Dressing Forceps Kron und Tupferzangen

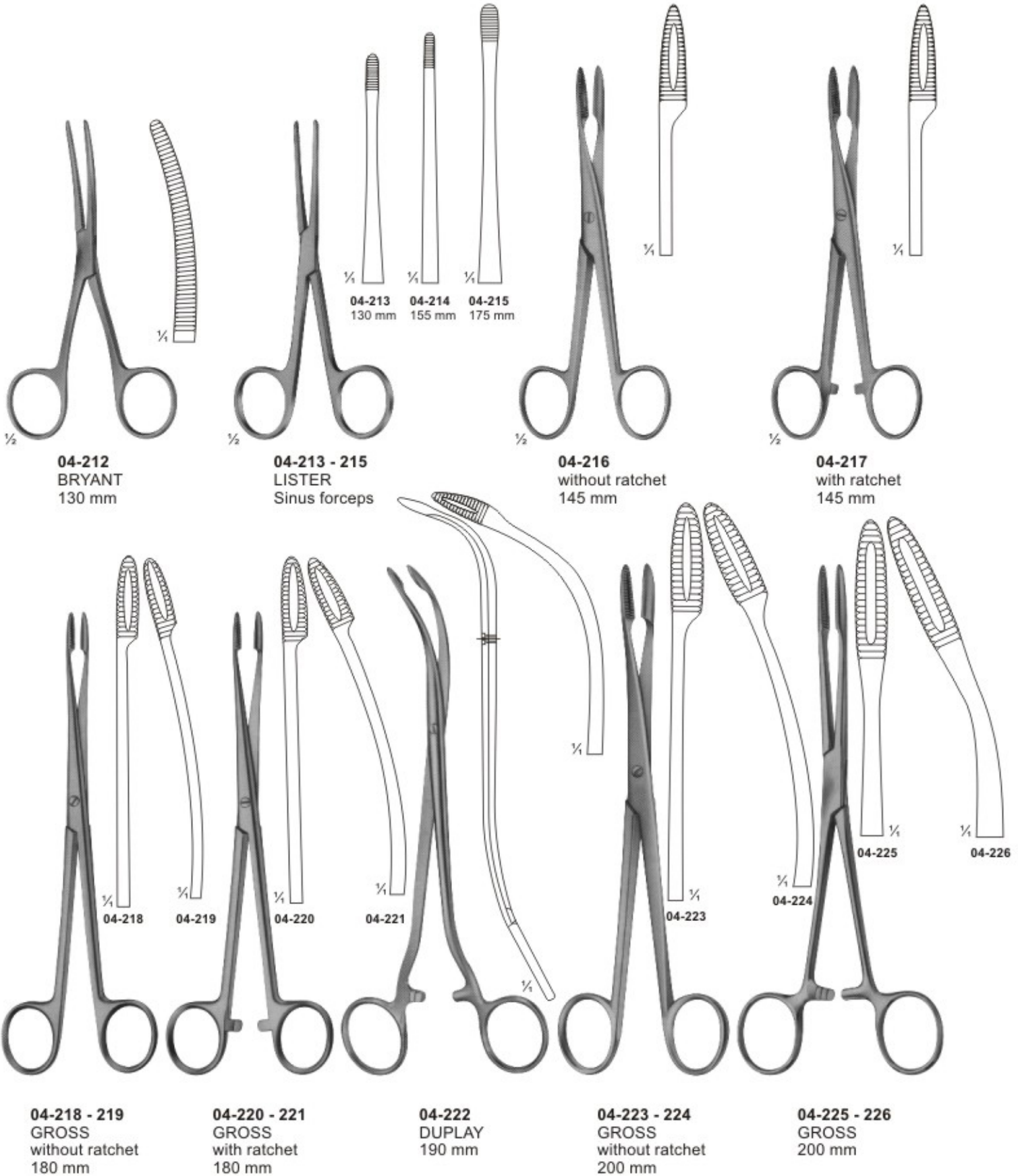

**Dressing-, Sponge holding-, Organ- and Tissue
Grasping Forceps**
Tupfer-, Schwamm-, Organ- und Gewebefaßzangen

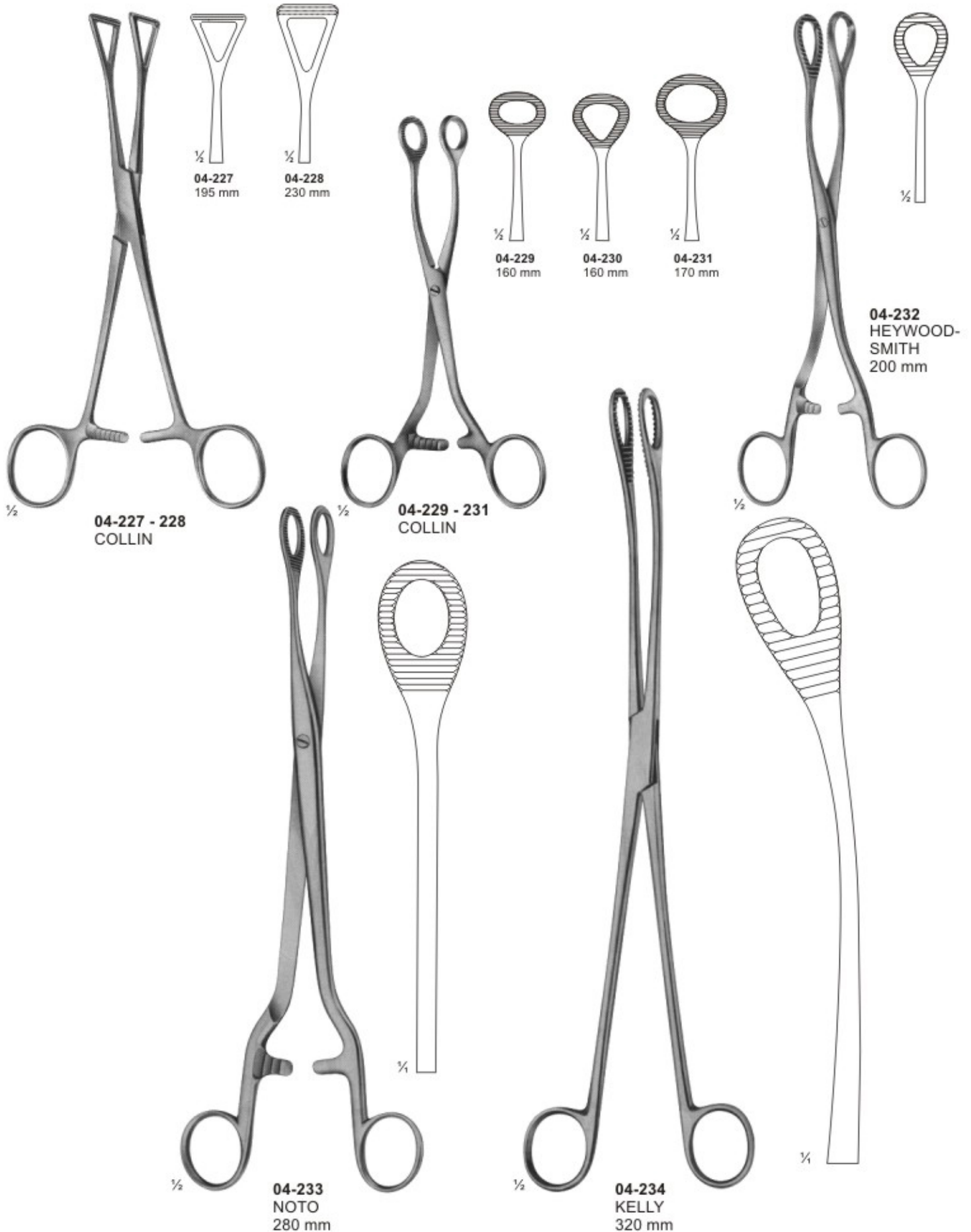

Artery Traction - and Tissue Grasping Forceps
Arterien- und Gewebefazangen

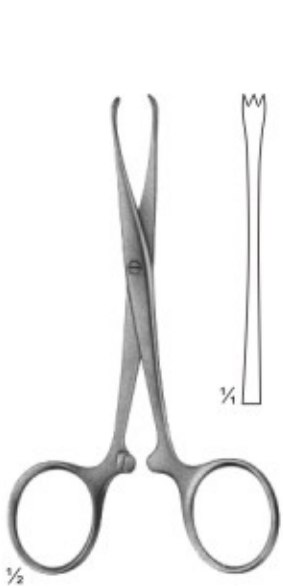

04-235
CHAPUT
 2 x 3 teeth
 125 mm

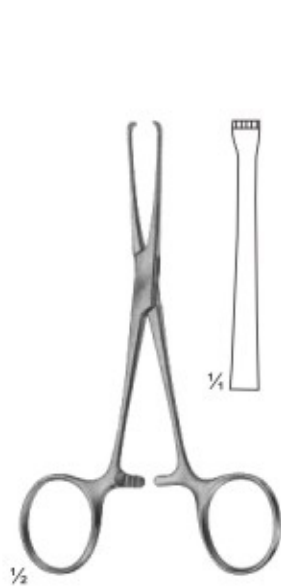

04-236
BABY-ALLIS
 4 x 5 teeth
 130 mm

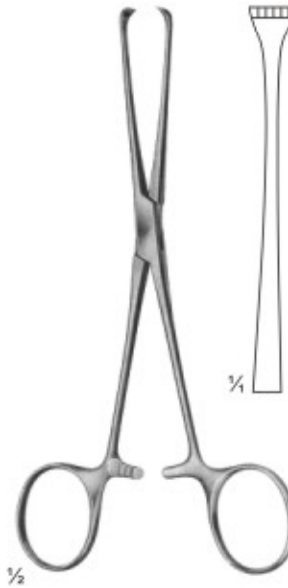

04-237
BOYS-ALLIS
 5 x 6 teeth sharp
 155 mm

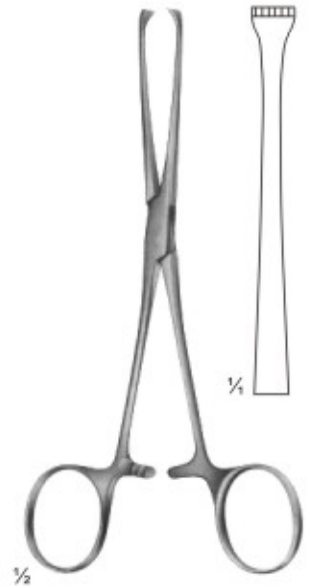

04-238
ALLIS
 5 x 6 teeth
 155 mm



04-239
LAHEY
 155 mm

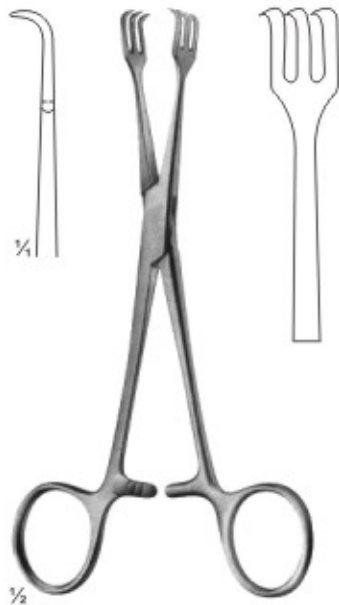

04-240
LAHEY
 155 mm

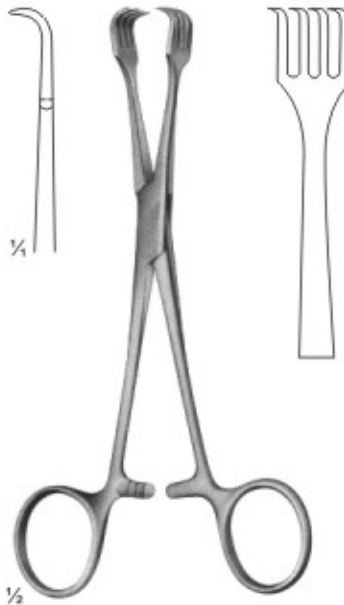

04-241
BRAUN
 155 mm

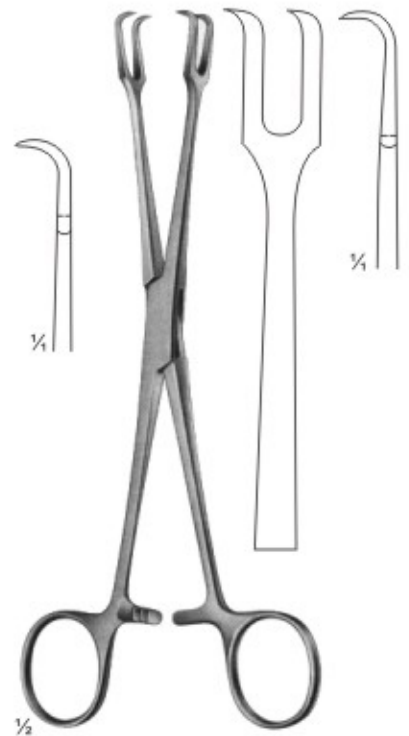

04-242
MUSEUX
 200 mm

Towel Clamps
Tuchklemmen

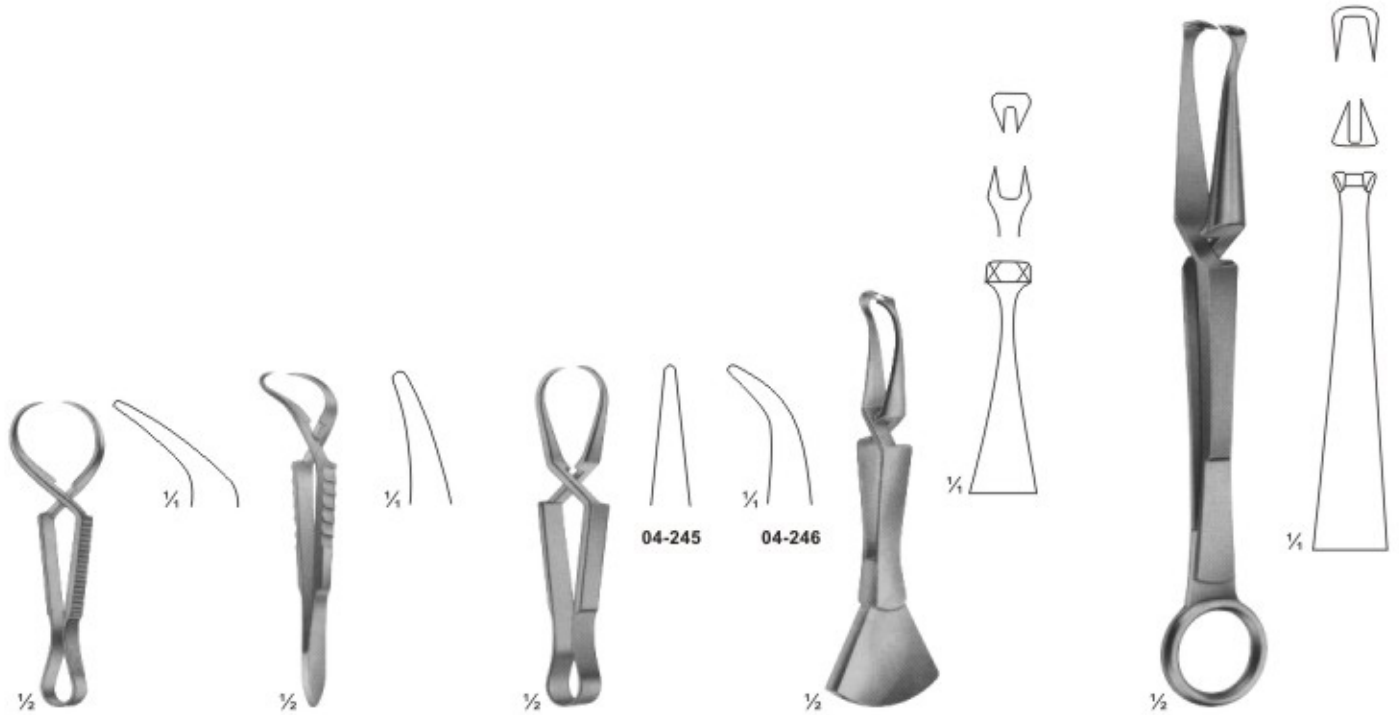

04-243
JONES
85 mm

04 - 244
ENGL. MOD.
85 mm

04 245 - 246
SCHAEDEL
85 mm

04-247
DOYEN
110 mm

04-248
DOYEN
180 mm

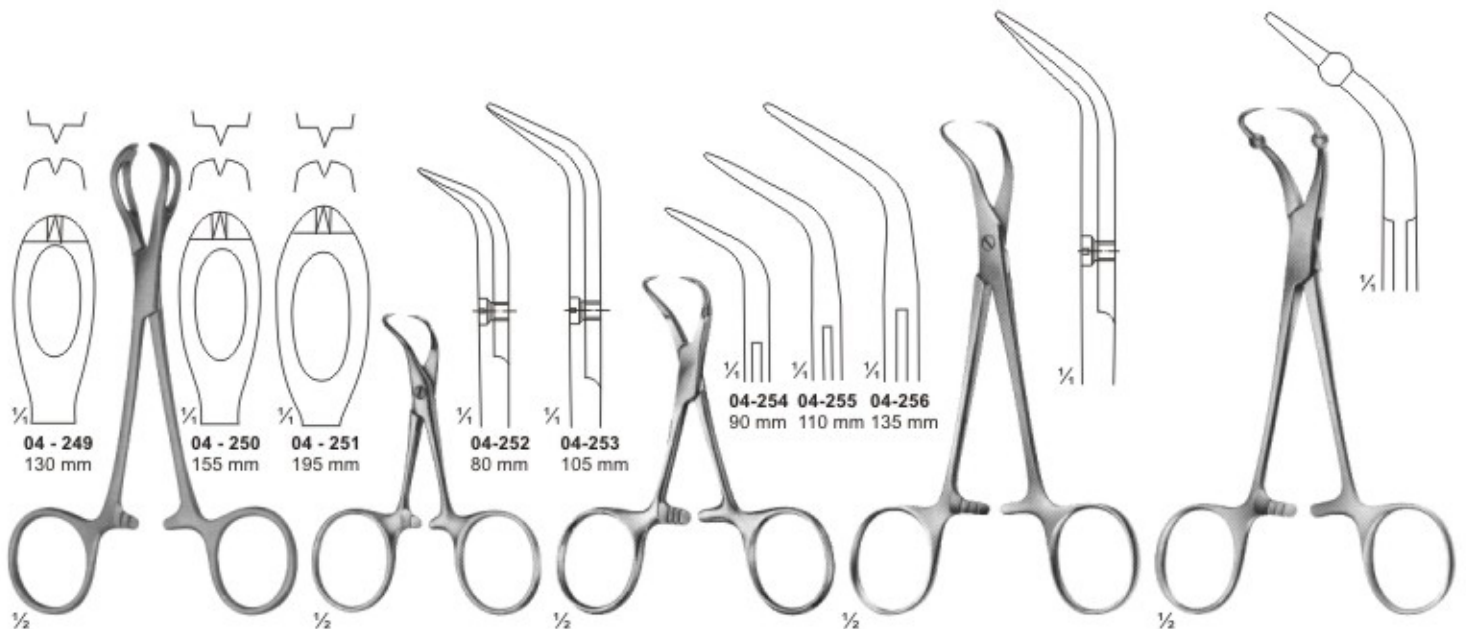

04 - 249
130 mm

04 - 250
155 mm

04 - 251
195 mm

04-252
80 mm

04-253
105 mm

04-254 04-255 04-256
90 mm 110 mm 135 mm

04-249 - 251
LANE

04-252 - 253
BACKHAUS

04-254 - 256
BACKHAUS

04-257
BACKHAUS-KOCHER
135 mm

04-258
ROEDER
135 mm

Muller Vessel Clips and Bulldog Clamps

GefaBclips nach MULLER und Bulldogklemmen



Closing force

04-259 straight 80g 50g

04-260 curved 80g 50g

04-261 curved tips 80g 50g

04-262 angled shaped 80g 50g

04-263 MULLER knee-bent 80g 50g

04-264 Muller Ligature Forceps

04-265 35 mm

04-266 35 mm

04-267 45 mm

04-268 45 mm

04-269 DIEFFENBACH 38 mm

04-270 DIEFFENBACH 48 mm

04-271 DIEFFENBACH 38 mm

04-272 DIEFFENBACH 48 mm

04-273 DIEFFENBACH 58 mm

04-274 DIEFFENBACH 58 mm

04-275 - 281 JOHNS-HOPKINS 91 mm

04-282 DE BAKEY-HESS 20 mm

04-275 38 mm

04-276 48 mm

04-277 56 mm

04-278 63 mm

04-279 70 mm

04-280 80 mm

04-281 91 mm

04-283 DE BAKEY length 50 mm jaws 27 mm

04-284 DE BAKEY length 48 mm jaws 27 mm

04-285 GLOVER length 57 mm jaws 35 mm

04-286 DE BAKEY length 73 mm jaws 38 mm

04-287 DE BAKEY length 99 mm jaws 63 mm

04-288 DE BAKEY length 95 mm jaws 54 mm

04-289 DE BAKEY L. 80 mm

04-290 DE BAKEY L. 90 mm

04-291 DE BAKEY L. 105 mm

04-292 DE BAKEY L. 124 mm

04-293 DE BAKEY L. 78 mm

04-294 DE BAKEY L. 86 mm

04-295 DE BAKEY L. 97 mm

04-296 DE BAKEY L. 114 mm

04-297 GLOVER L. 68 mm

04-298 GLOVER L. 96 mm

04-299 GLOVER L. 117 mm

04-300 GLOVER L. 65 mm

04-301 GLOVER L. 91 mm

04-302 GLOVER L. 110 mm

Jaw, cross serrated

Delicate Haemostatic Forceps Feine Arterienklemmen

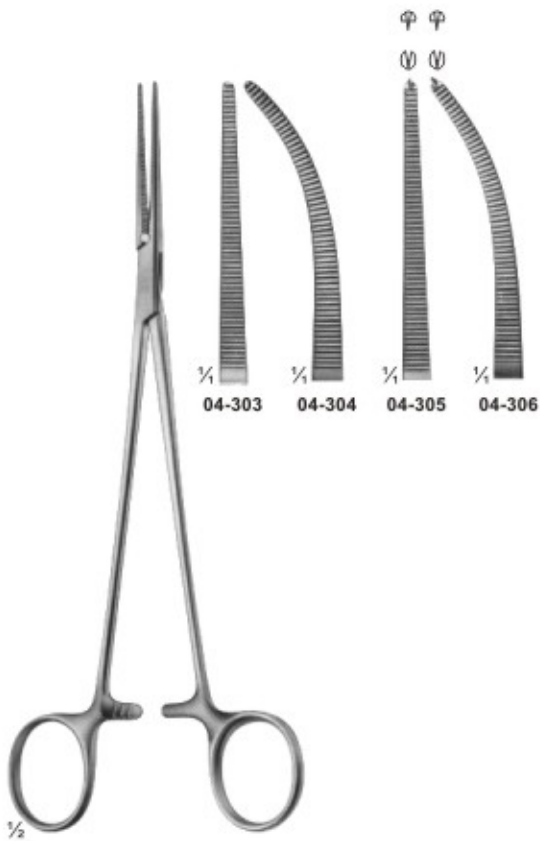

04-303 - 306
HALSTED-MOSQUITO
200 mm

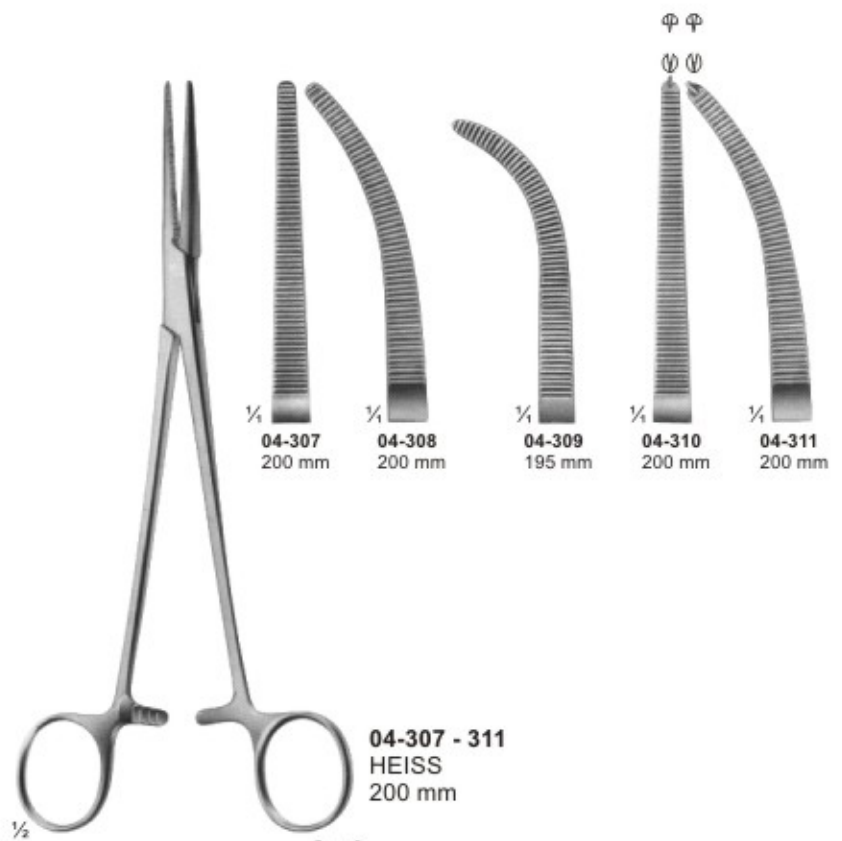

04-307 - 311
HEISS
200 mm



04-312 - 313
HALSTED
215 mm

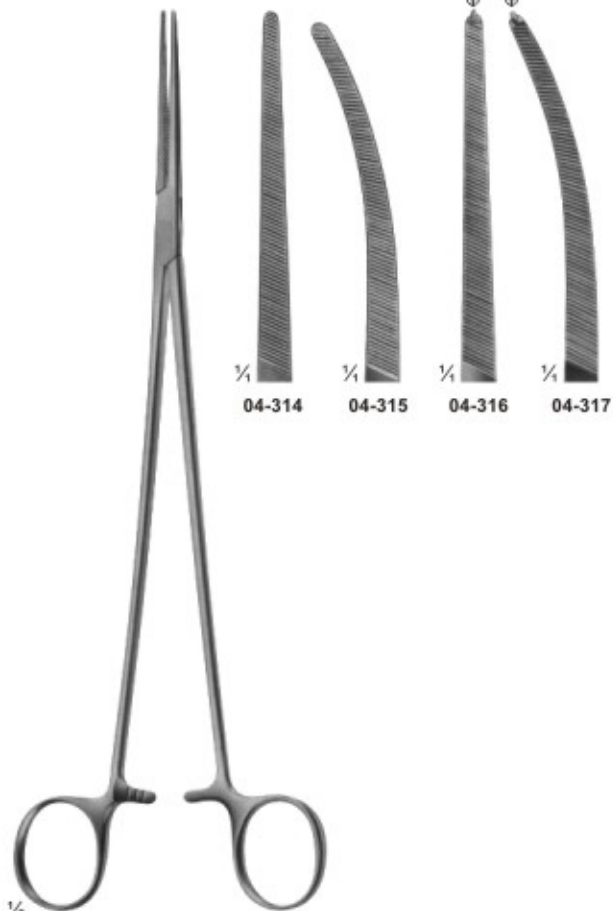

04-314 - 317
BENGOLEA
245 mm

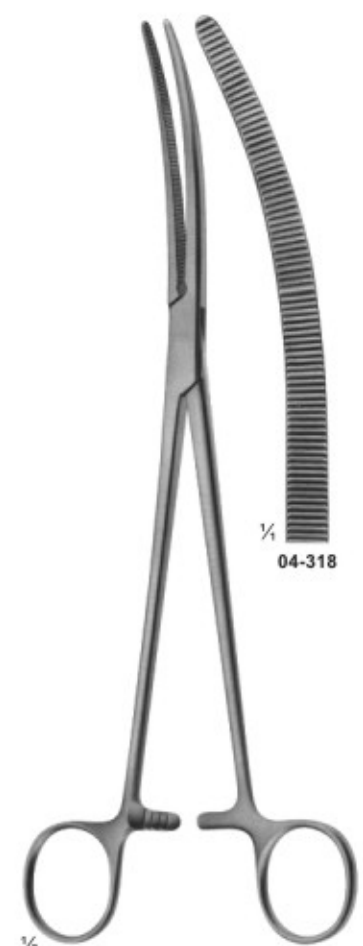

04-318
CRAFOORD
245 mm

Haemostatic Forceps Arterienklemmen

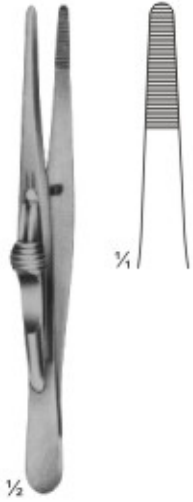

04-319
FRICKE
Artery forceps
130 mm



04-320
KRONLEIN
130 mm

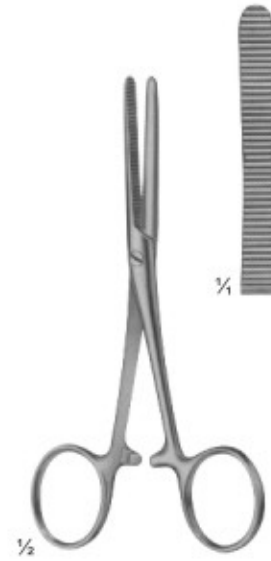

04-321
PEAN
125 mm



04-322 - 323
PEAN



04-324
PEAN
125 mm



04-325 - 326
PEAN

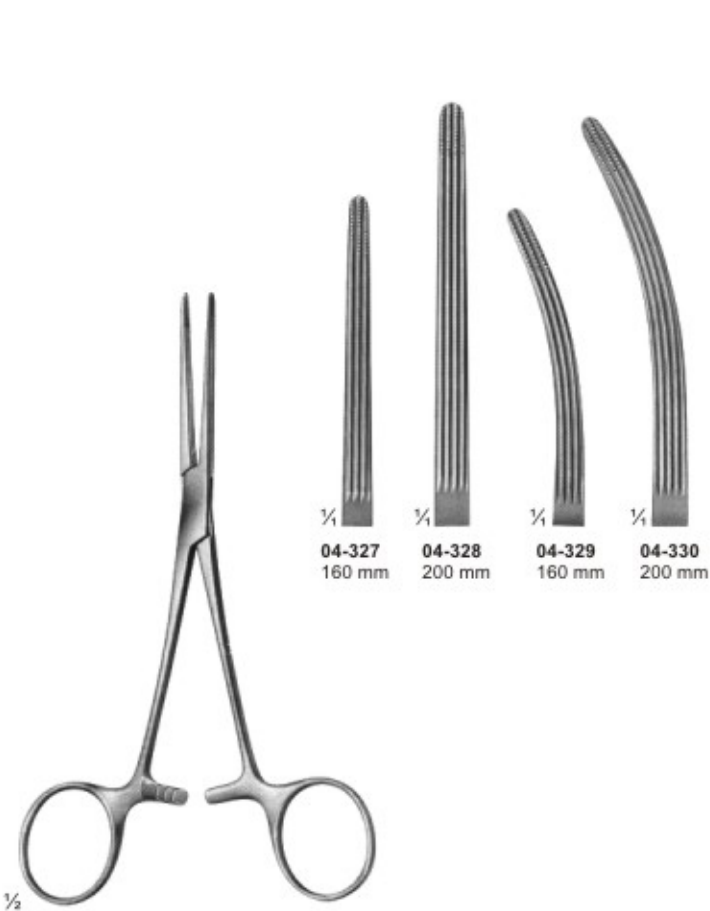

1/2 **04-327 - 330**
 ROCHESTER-CARMALT

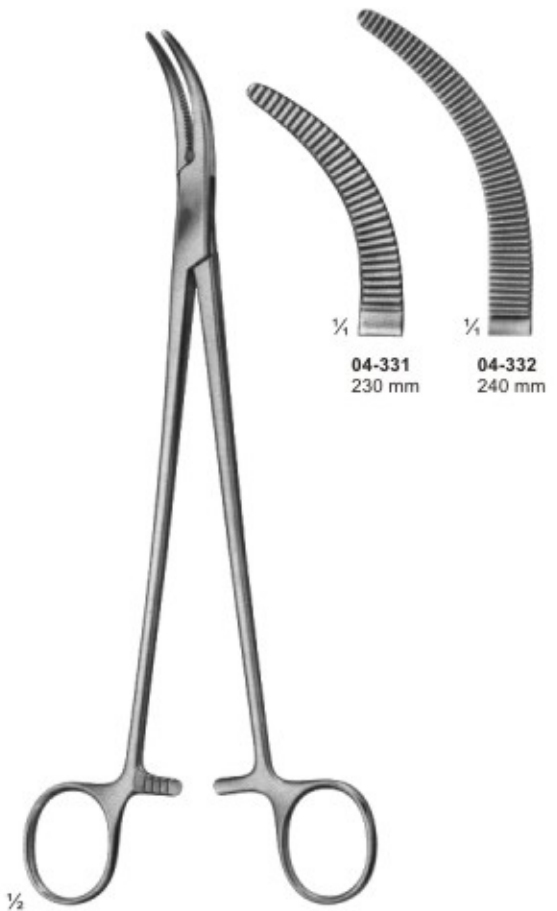

1/2 **04-331 - 332**
 MOYNIHAN

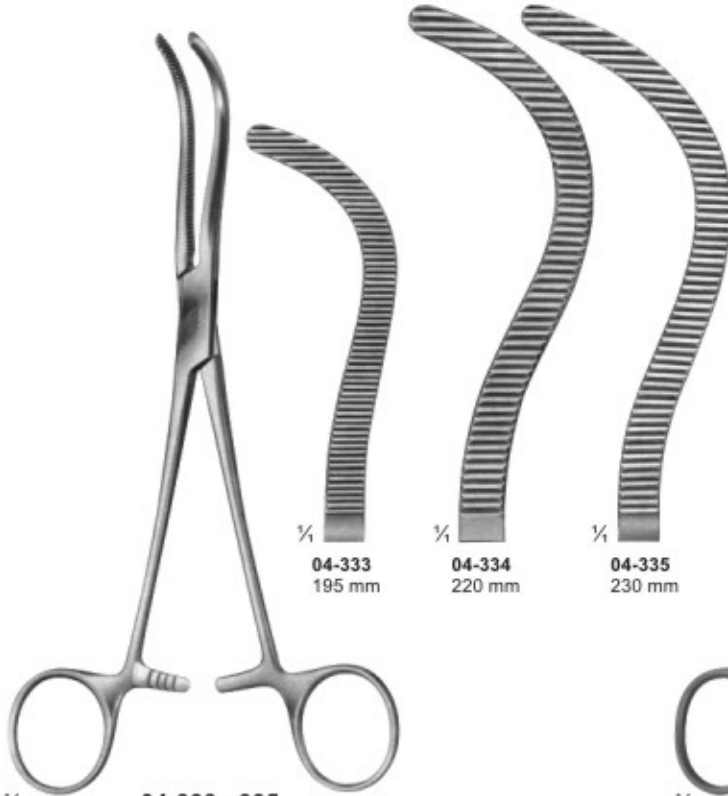

1/2 **04-333 - 335**
 PEAN

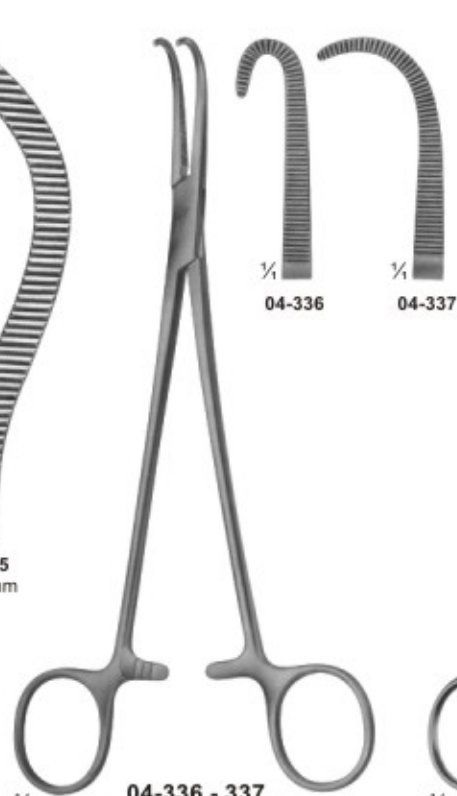

1/2 **04-336 - 337**
 NEGUS
 190 mm

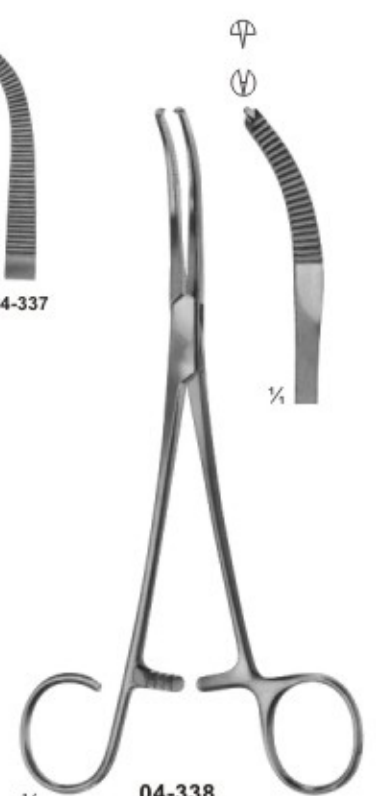

1/2 **04-338**
 MIKULICZ
 185 mm

Dissecting- and Ligature Forceps Präparier- und Ligaturklemmen



04-339
MIXTER-O'SHAUGHNESSY
190 mm

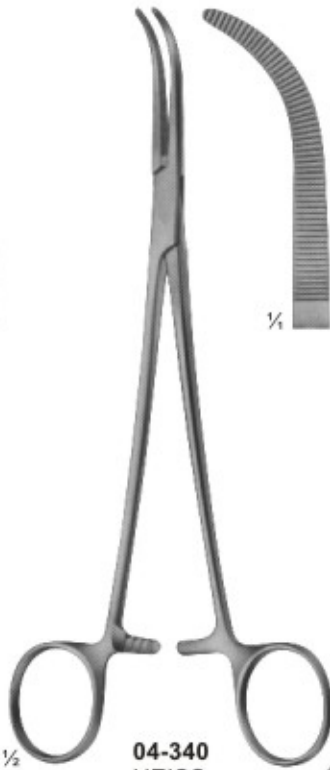

04-340
HEISS
195 mm

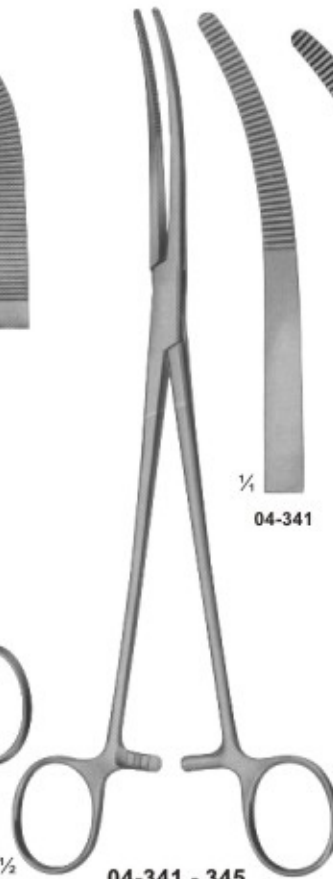

04-341 - 345
RUMEL
240 mm

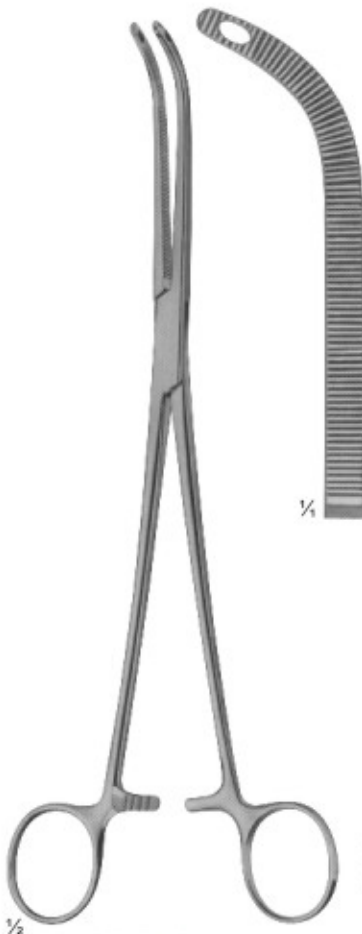

04-346
FINOCHIETTO
245 mm



04-347
MIXTER
230 mm



04-348
LAWRENCE
270 mm



04-349 - 350
ZENKER



04-350
290 mm

**Hysterectomy Forceps, Vaginal Clamps
and Compression Forceps**
Hysterektomie, Vaginalklemmen und klemmzangen

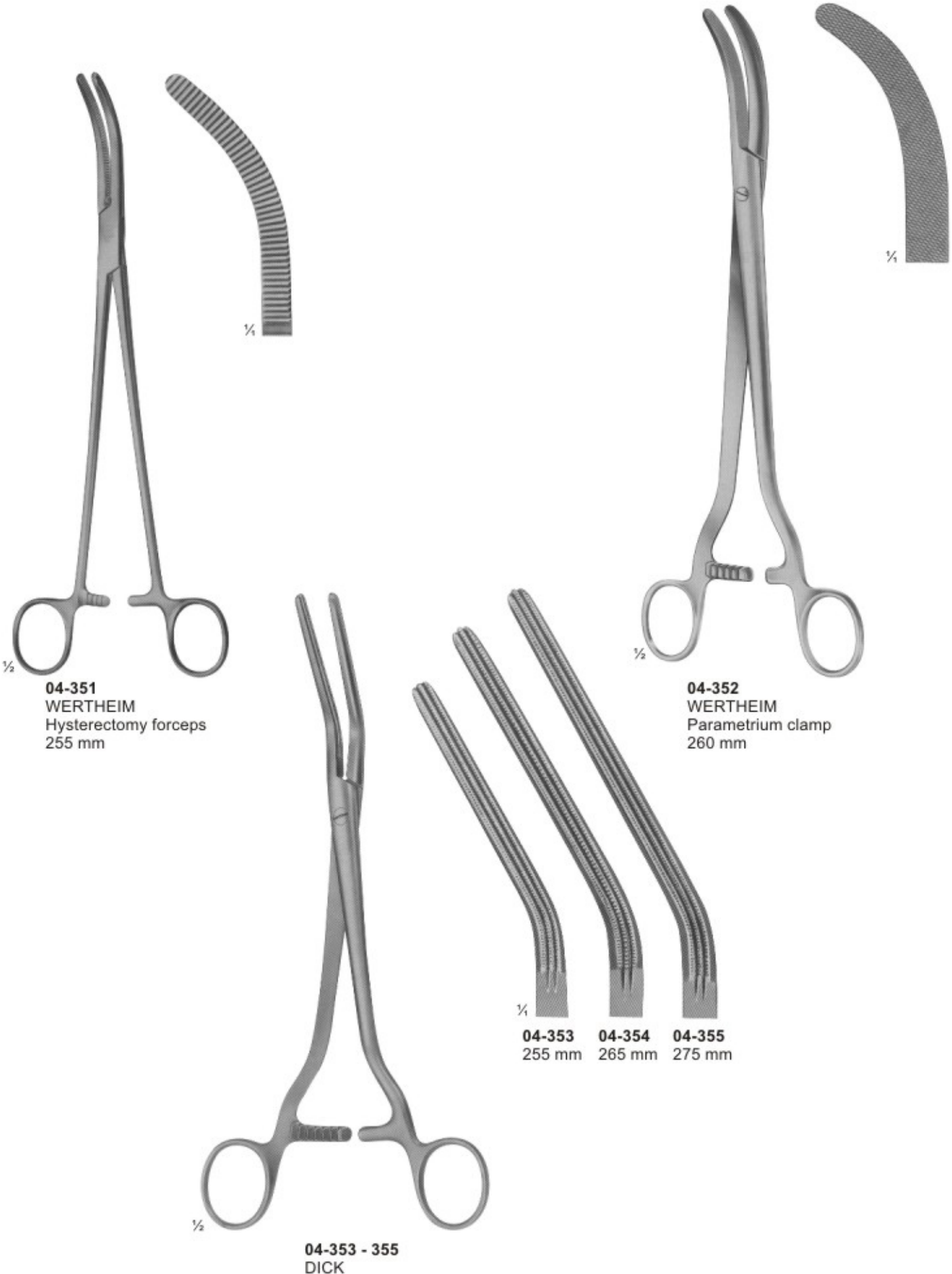

Hysterectomy Forceps, Vaginal Clamps
and Compression Forceps
Hysterektomie, Vaginalklemmen und klemmzangen



04-356
WERTHEIM
250 mm

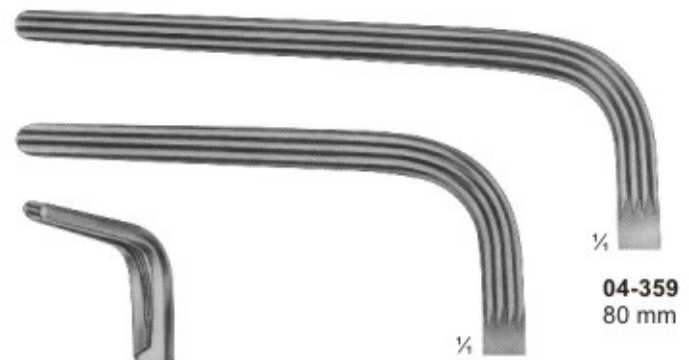

04-358
60 mm

04-359
80 mm



04-357
WERTHEIM-CULLEN
215 mm



04-358 - 359
230 mm

Needle Holders for micro surgery
Nadelhalter für Mikorchirurgie



05-101
ROHRSCHEIDER
 with copper inserts
 100 mm



05-102
KALT
 with catch
 135 mm



05-103
ARRUGA
 with catch
 135 mm



05-104 - 105
CASTROVIEJO
 with catch
 145 mm



05-106 - 107
 without Catch
 160 mm



05-108 - 109
 without catch
 185 mm

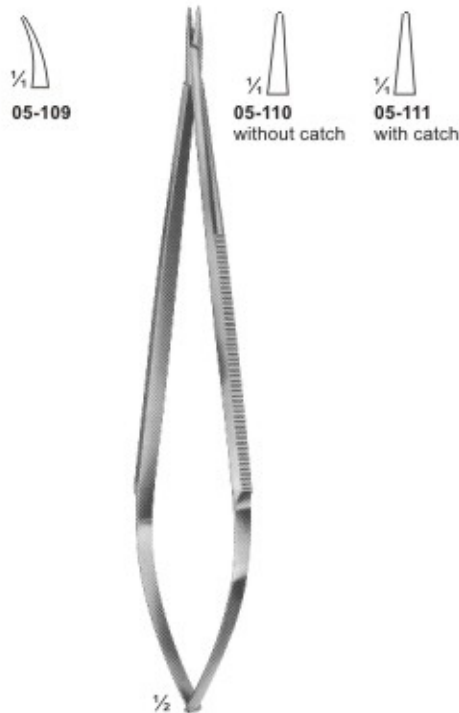

05-110 - 111
JACOBSON
 185 mm



05-112
 without catch
 195 mm



05-113 - 114
YASARGIL
 with catch
 200 mm

Needle Holders Nadelhalter



Needle Holders
Nadelhalter

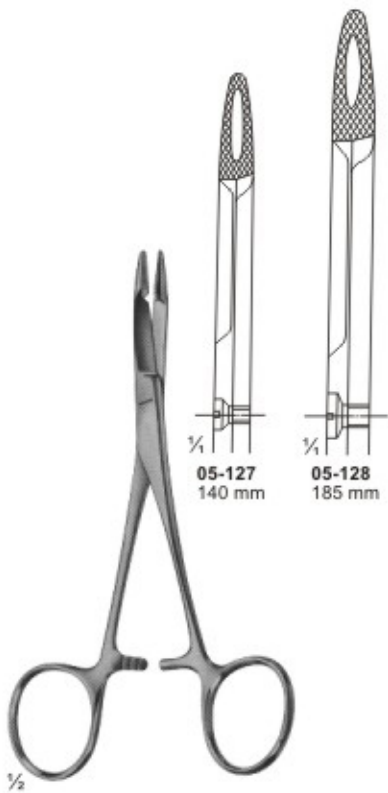

05-127 - 128
HEGAR-OLSEN
255 mm

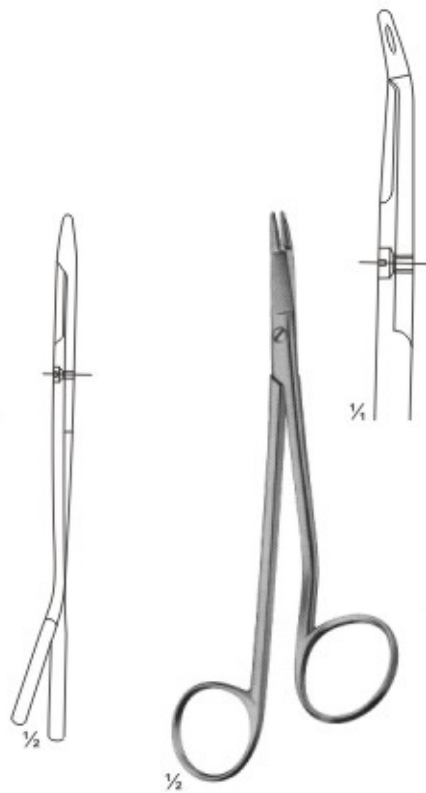

05-129
GILLIES
150 mm



05-130
GILLIES
160 mm

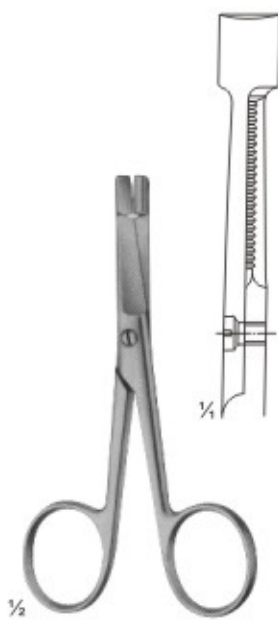

05-131
EISELSBERG
115 mm

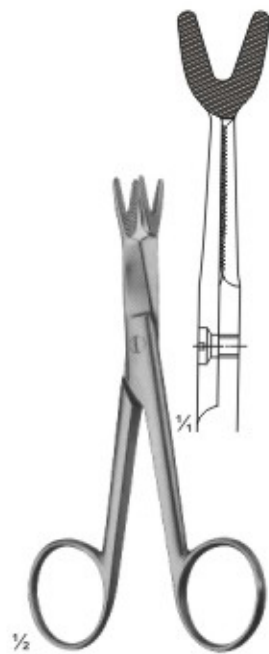

05-132
SCHOEMAKER-LOTH
125 mm



05-133
CRILE
150 mm



05-134
TOENNIS
Elastic pattern for
dura-or intestinal suture
180 mm

Suture Instruments - Reverdin Needles

Naht-Instrumente-Reverdin-Nadeln

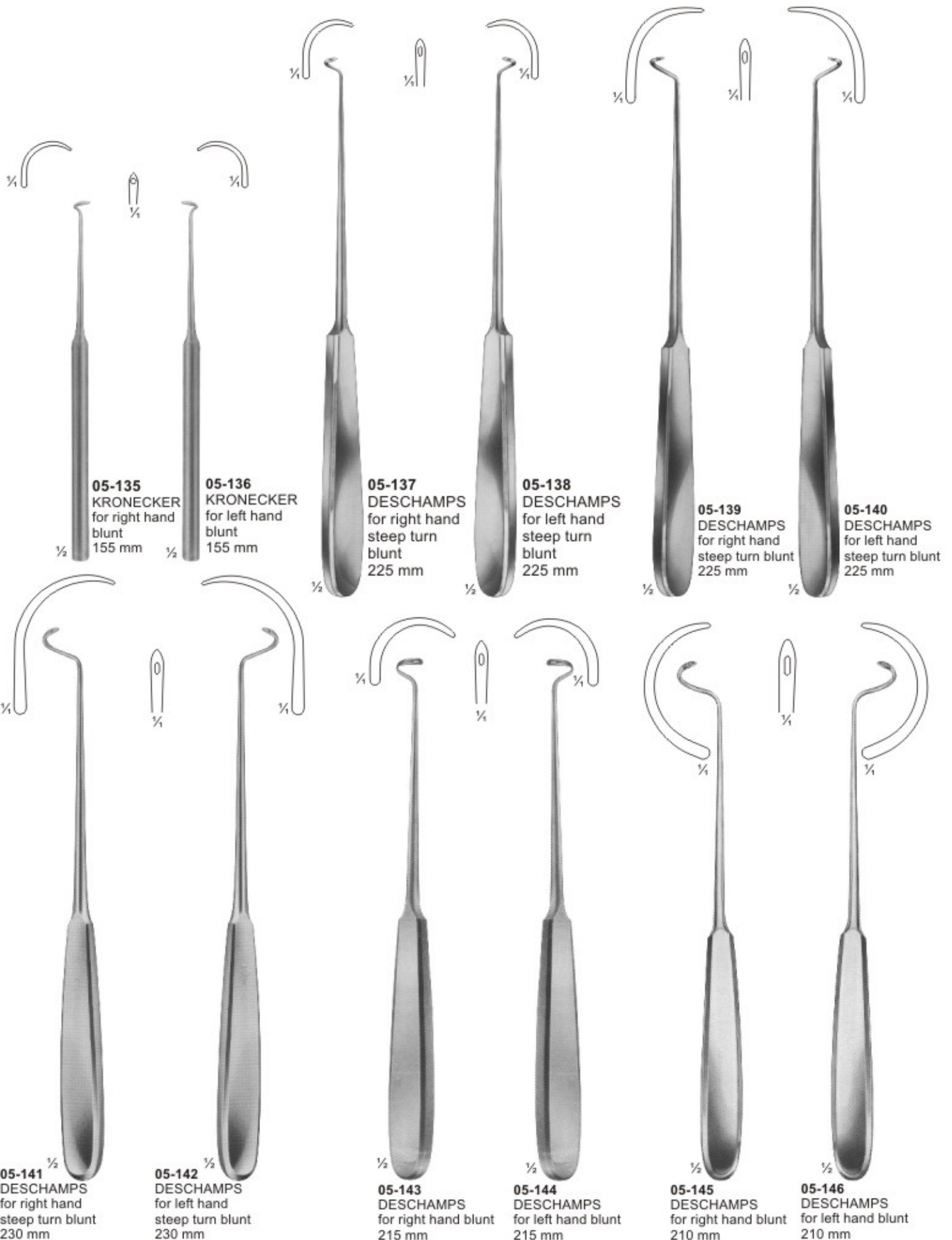



05-147 130 mm
05-148 145 mm
05-149 160 mm
Directors

05-150
DOYEN
145 mm
Directors

05-151
NELATON
160 mm
Directors

05-152
Director with tip
Diam. Of tip 3,3 mm
140 mm

05-153
BRODIE
Director with tip,
Diam. Of tip 3,5 mm
200 mm

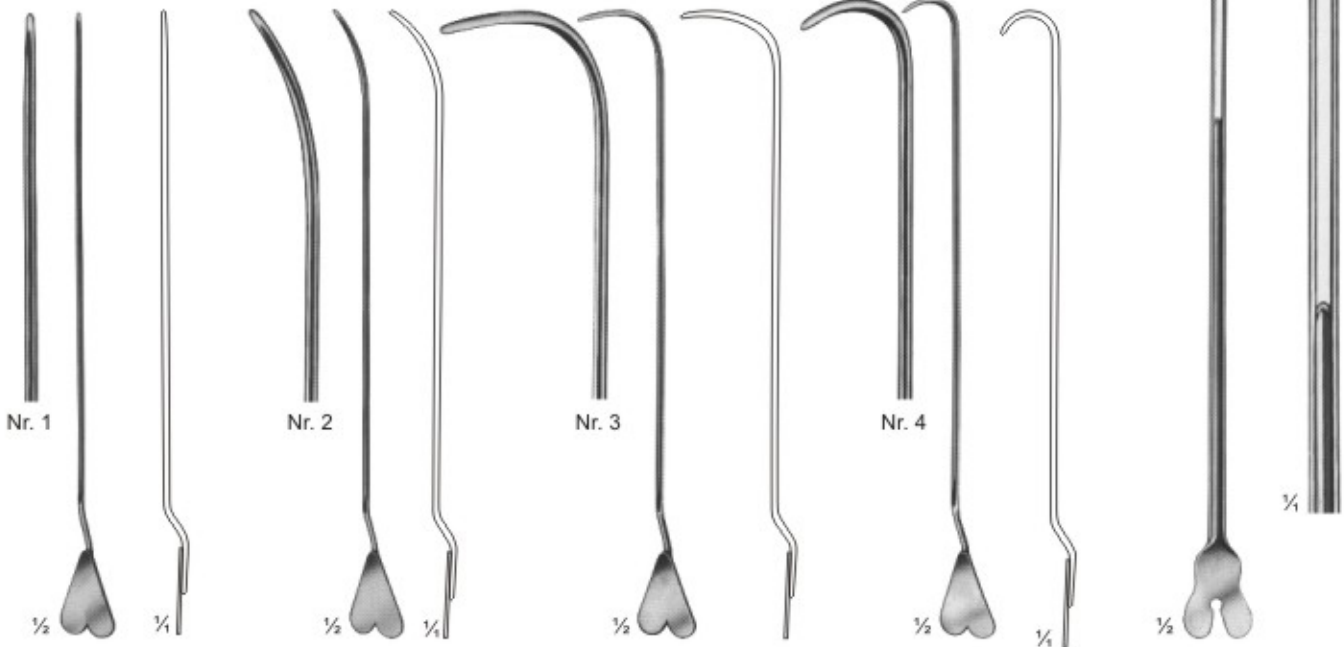

05-154
LOCKHART-MUMMERY
165 mm

05-155
LOCKHART-MUMMERY
165 mm

05-156
LOCKHART-MUMMERY
165 mm

05-157
LOCKHART-MUMMERY
165 mm

05-158
Director with wire
loop, malleable
190 mm



05-159 145 mm
05-160 160 mm
05-161 200 mm
Probes with eye



05-162
Myrtle leaf probe
145 mm



05-163 130 mm
05-164 145 mm
05-165 160 mm
05-166 180 mm
05-167 200 mm



05-168
Probes



05-169
Double ended probe,
malleable, diam. of tips
3 mm with hole
190 mm



05-170
Double ended probes,
tin, malleable,
diam. of tips
3,5 mm with hole
250 mm, 300 mm



05-171
Double ended probes,
tin, malleable,
diam. of tips 4 mm
400 mm



05-172 1,5 mm
05-173 2,0 mm
05-174 2,5 mm
300 mm

Suturing Instrument Set, Pocket Instrument Set Wundnahtbesteck, Chirurgisches Taschenbesteck



05-175

Suturing instruments set, in metal case consisting of: Scissors, curved, sharp/sharp, 115mm
25 MICHEL clip, 16 x 3mm
1 Delicate tissue forceps, 130mm
1 Scalpel, bellied
1 MATHIEU needle holder, 140mm
1 Perforated metal case, stainless containing:
1 Suture needle
1 item 1 item

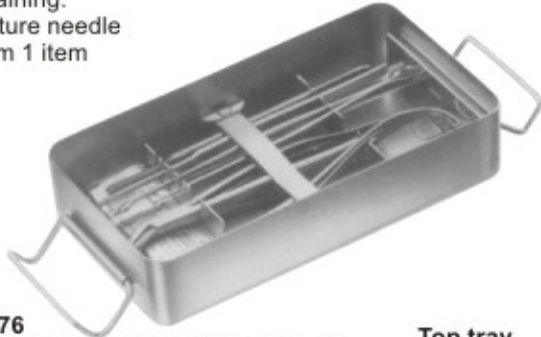

05-176

Pocket instrument set, in metal case consisting of:

Bottom tray

1 MATHIEU needle holder, 140mm
1 MICHEL clip forceps, combined
1 Myrtle leaf probe, 130mm
1 Sharp double curette
1 Skin hook
1 Detachable scalpel handle, no.4
1 Perforated metal case, containing
6 Scalpel blades
1 Perforated metal case, stainless, containing
1 Suture needle
1 item
1 item

Top tray

1 Tissue forceps, 130mm
1 KOCHER haemostatic forceps, 130mm
1 Straight surgical scissors, 130mm
1 Dissecting forceps, 130mm
1 FEILCHENFELD splinter forceps, 115mm
25 MICHEL clip, 16 x 3mm
1 Flacon of suture skin, sterile in alcohol

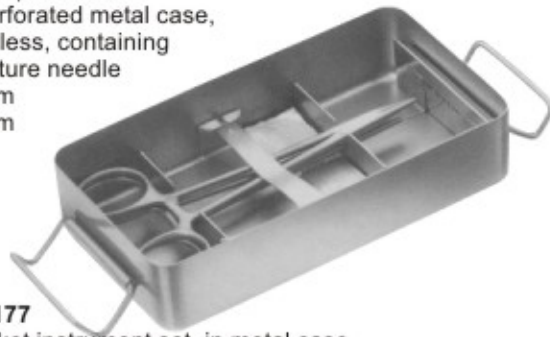

05-177

Pocket instrument set, in metal case consisting of:

Bottom tray

1 MAYO-HEGER needle holder, 150mm
1 MICHEL clip forceps, combined
1 Myrtle leaf probe, 130mm
1 Sharp double curette
1 Skin hook
1 Detachable scalpel handle, no. 4
1 Perforated metal case, consisting
6 Scalpel blades
1 Perforated metal case, stainless, consisting:
1 Suture needle
1 item, & 1 item

Top tray

1 Tissue forceps, 130mm
1 CRILE haemostatic forceps, 140mm
1 Straight surgical scissors, 130mm
1 Dissecting forceps, 130mm
1 FEILCHENFELD splinter forceps, 115mm
25 MICHEL clip, 16 x 3mm
1 Flacon of suture silk, sterile in alcohol



Fine Wound Retractors (Dura- and Skin Retractors)
Feine Wundhakchen (Dura- und Hauthakchen)

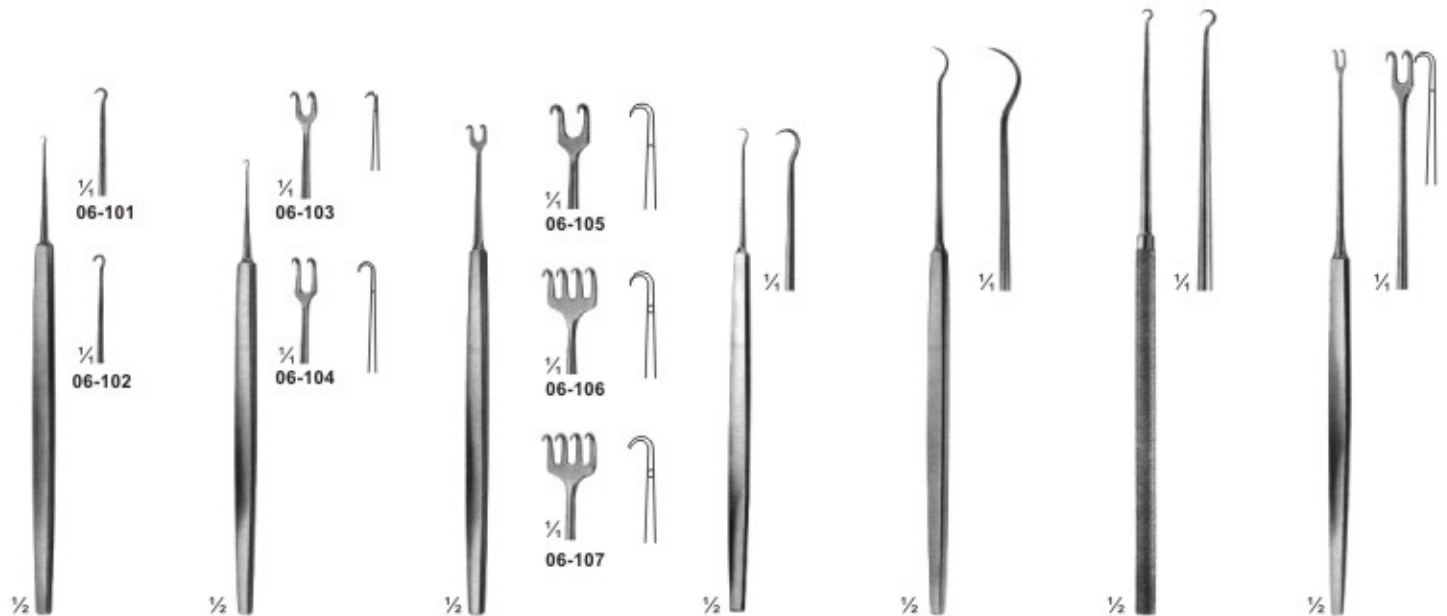

06-101 Sharp
06-102 Blunt
GRAEFE
 125 mm

06-103 125 mm
06-104 130 mm
 sharp
GUTHRIE

06-105 130 mm
06-106 135 mm
 sharp
ROLLET
06-107 135 mm
 blunt

06-108
FRAZIER
 Dura retractors
 130 mm

06-109
TONNIS
 Dura retractors
 150 mm

06-110
KILNER
 160 mm

06-111
FREER
 150 mm

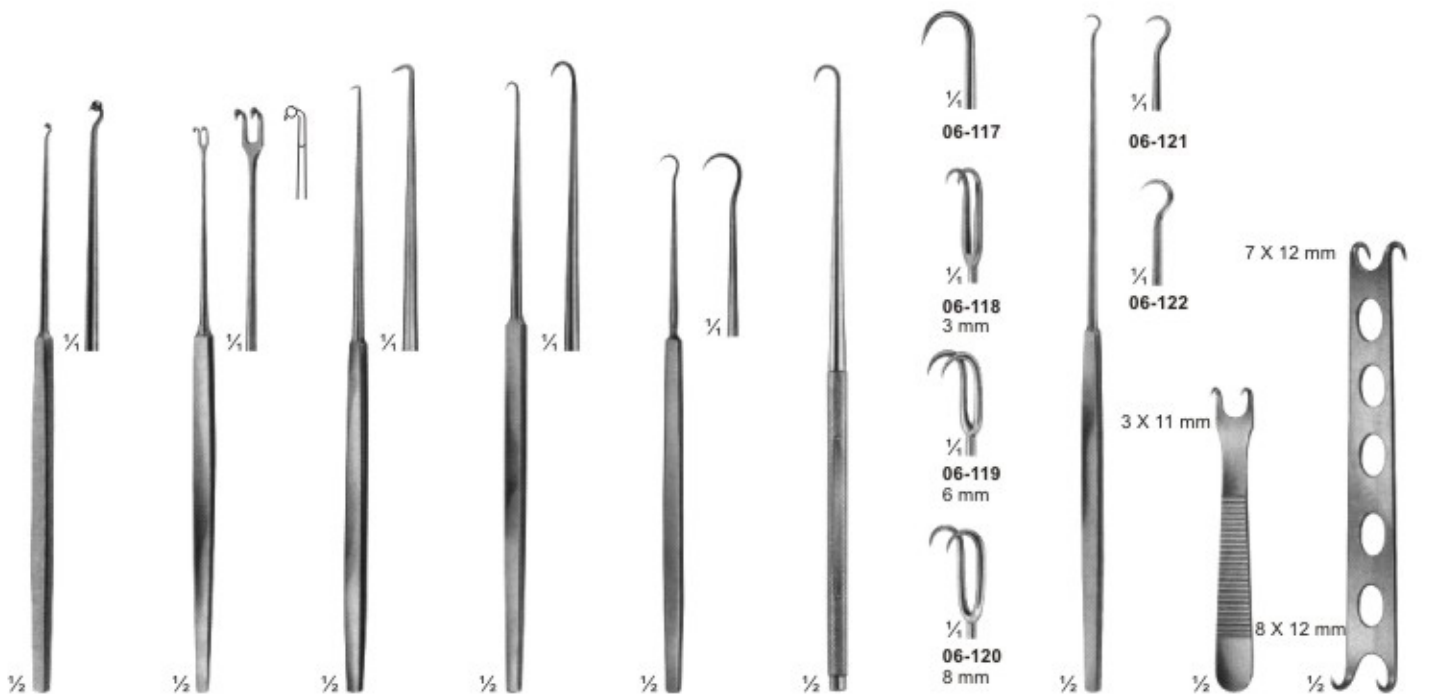

06-112
MULLER
 150 mm

06-113
MULLER
 150 mm

06-114
COTTLE
 160 mm

06-115
COTTLE
 160 mm

06-116
JAEGER
 135 mm

06-117 - 120
JOSEPH
 165 mm

06-121 - 122
GILLIES
 180 mm

06-123
KILNER
 sharp
 80 mm

06-124
CONVERSE
 blunt
 120 mm

Retractors With treangle handle Wundhaken mit Treangle-Griff

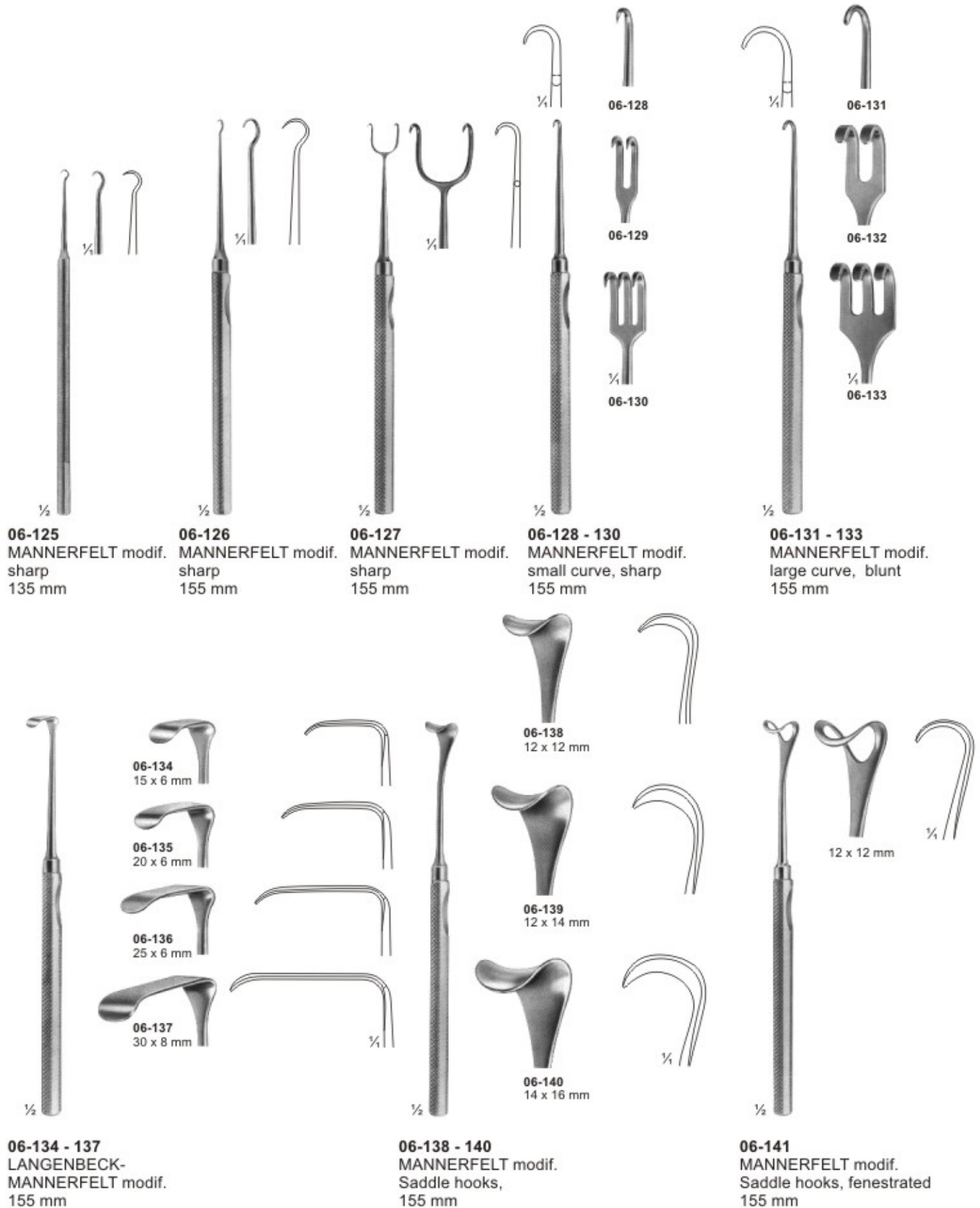

Retractors Wundhaken



06-142
MASING
140 mm



06-143
COTTLE
140 mm



06-144 - 148
DESMARRES
140 mm



06-145
9 x 12 mm

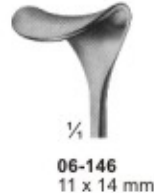

06-146
11 x 14 mm



06-147
12 x 16 mm



06-148
13 x 18 mm



06-149
13 x 13 mm



06-150
12 x 16 mm

06-149 - 150
KONIG
180 mm



10 x 10 mm

06-151
CUSHING-KOCHER
175 mm



06-152
20 x 12 mm

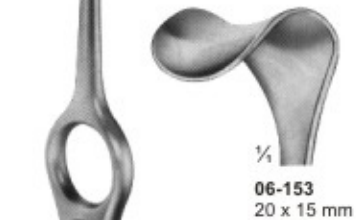

06-153
20 x 15 mm

06-152 - 153
KOCHER
205 mm

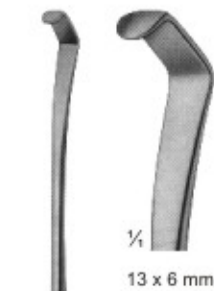

13 x 6 mm

06-154
SCHOENBORN
200 mm



06-155
10 x 13 mm



06-156
14 x 18 mm

06-155 - 156
CUSHING
205 mm



20 x 15 mm

20 x 19 mm

06-157
205 mm

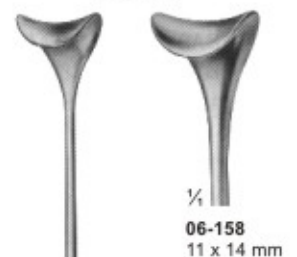

06-158
11 x 14 mm

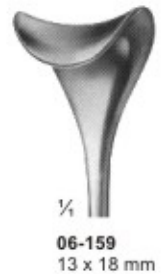

06-159
13 x 18 mm



06-160
15 x 22 mm

06-158 - 160
CUSHING
250 mm

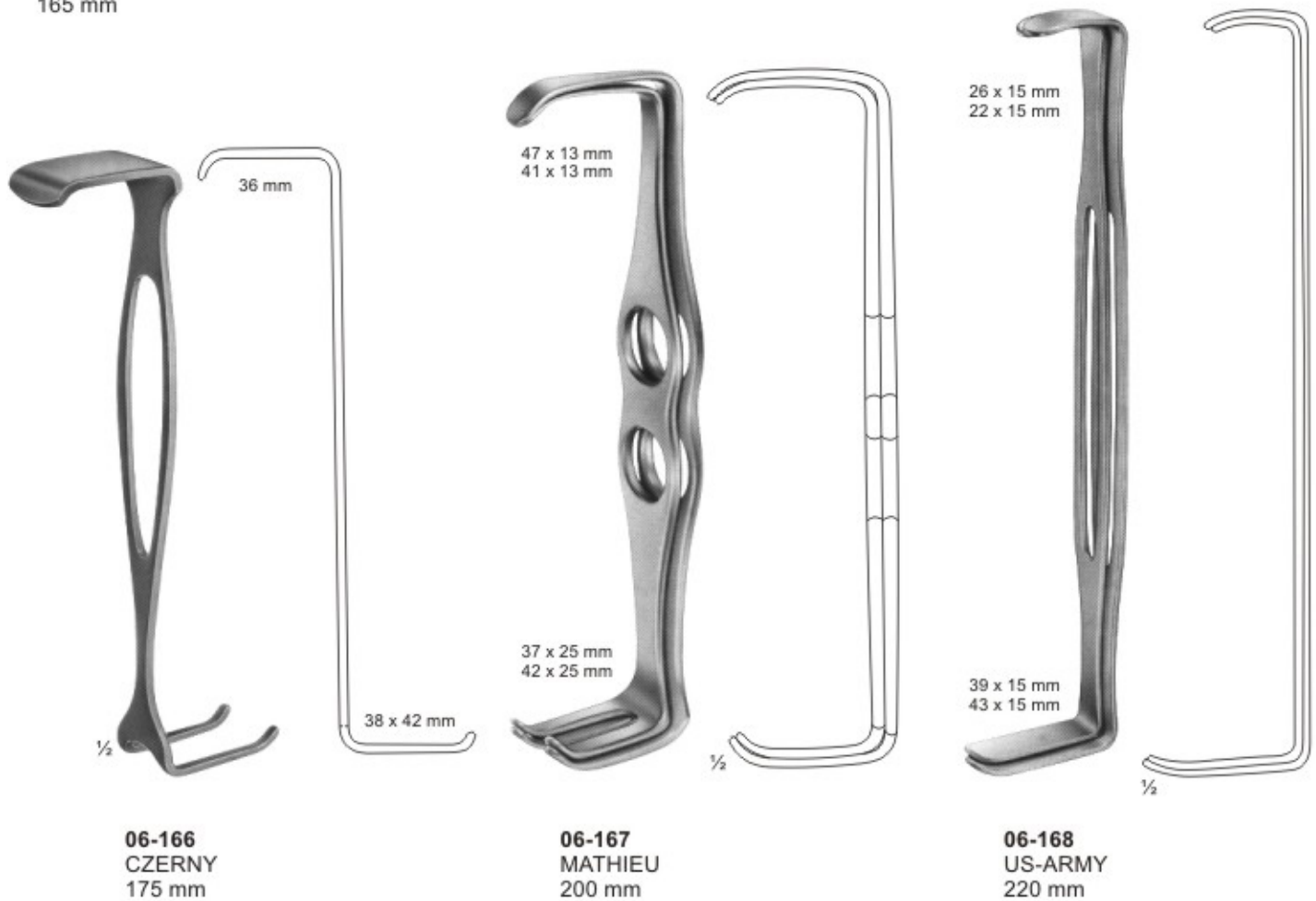
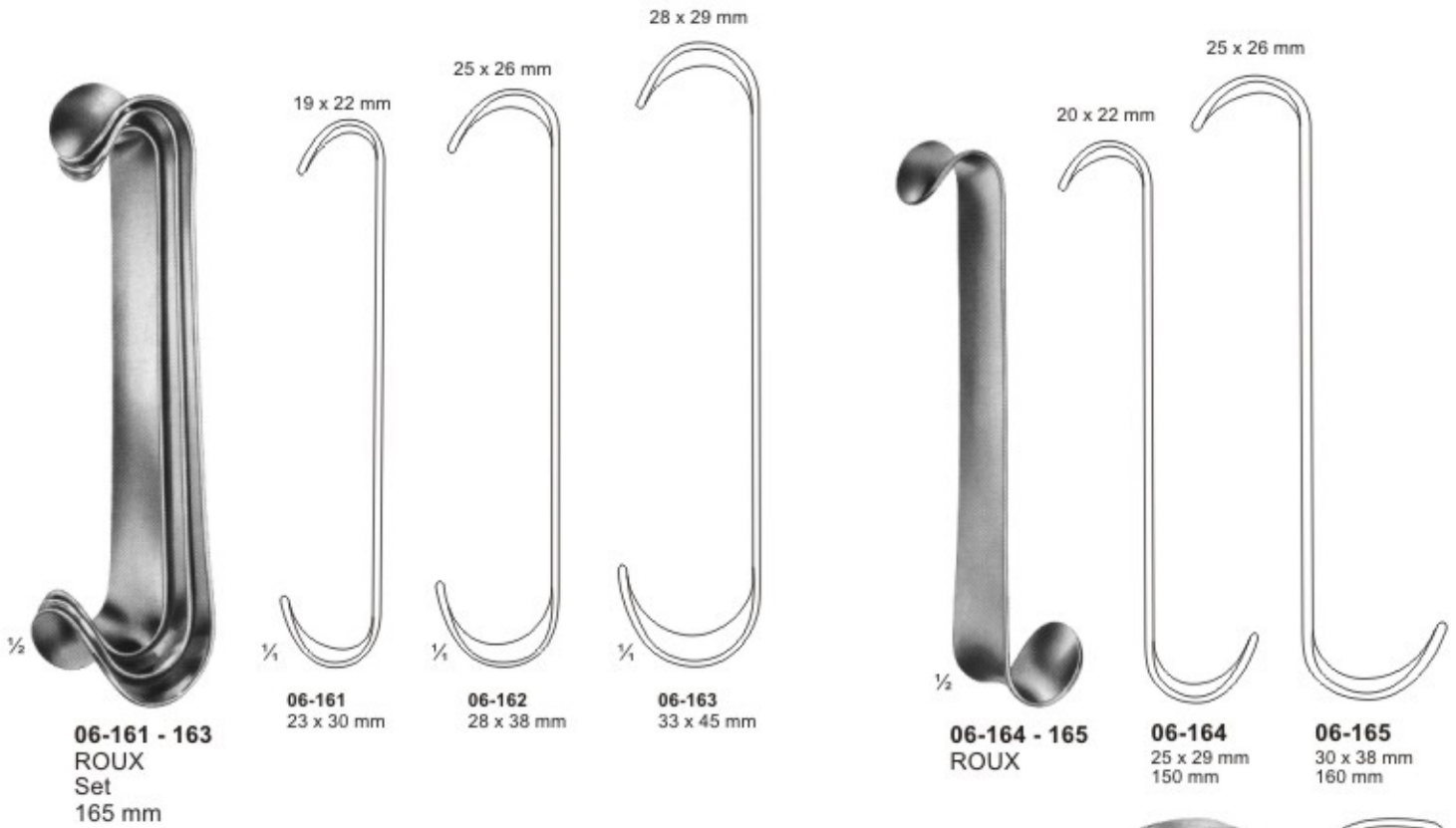

Bone Retractors and Retractors Knochen- und Wundhaken



06-169
KOCHER
sharp
205 mm



06-170
KOCHER
sharp
220 mm



06-171
KOCHER
sharp
220 mm



06-172
VOLKMANN
blunt
220 mm



06-173
VOLKMANN
sharp
220 mm



06-174 - 181
VOLKMANN
225 mm



Sharp



06-174
9 x 8 mm



06-175
9 x 13 mm



06-176
9 x 19 mm



06-177
9 x 29 mm



Blunt



06-178
8,5 x 8 mm



06-179
8,5 x 13 mm



06-180
8,5 x 19 mm



06-181
8,5 x 29 mm

Retractors Wundhaken



06-182
15 x 15 mm
220 mm

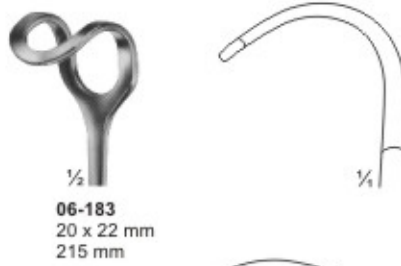

06-183
20 x 22 mm
215 mm

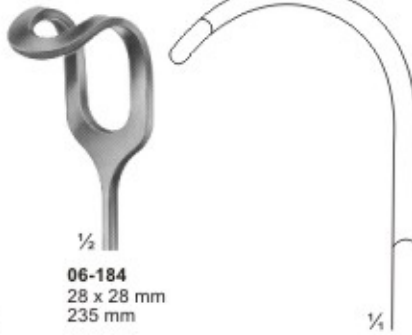

06-184
28 x 28 mm
235 mm



06-185
BUCHS
205 mm

38 x 18 mm



06-186
CASPAR
210 mm

67 x 17 mm



06-187
KOCHER
230 mm

36 x 20 mm

Retractors, Vario Retractor System
Wundhaken, Vario- Wundhaken-System



06-212 80 x 20 mm



06-188 - 194
BRUNNER
 275 mm

- 06-188** 80 x 20
- 06-189** 100 x 25
- 06-190** 120 x 25
- 06-191** 130 x 30
- 06-192** 140 x 30
- 06-193** 160 x 30
- 06-194** 180 x 30

1/2



06-195
 Handle with cold
 light carrier for
 retractor blades.
 280 mm

1/2



Handle arrange-
 ment verriable

Retractors, Lung Spatulas Wundhaken, Lungenspatel



Retractors for deep surgery (Abdominal Retractors)
Wundhaken für Eingriffe in der Tiefe (Bauchdeckenhaken)

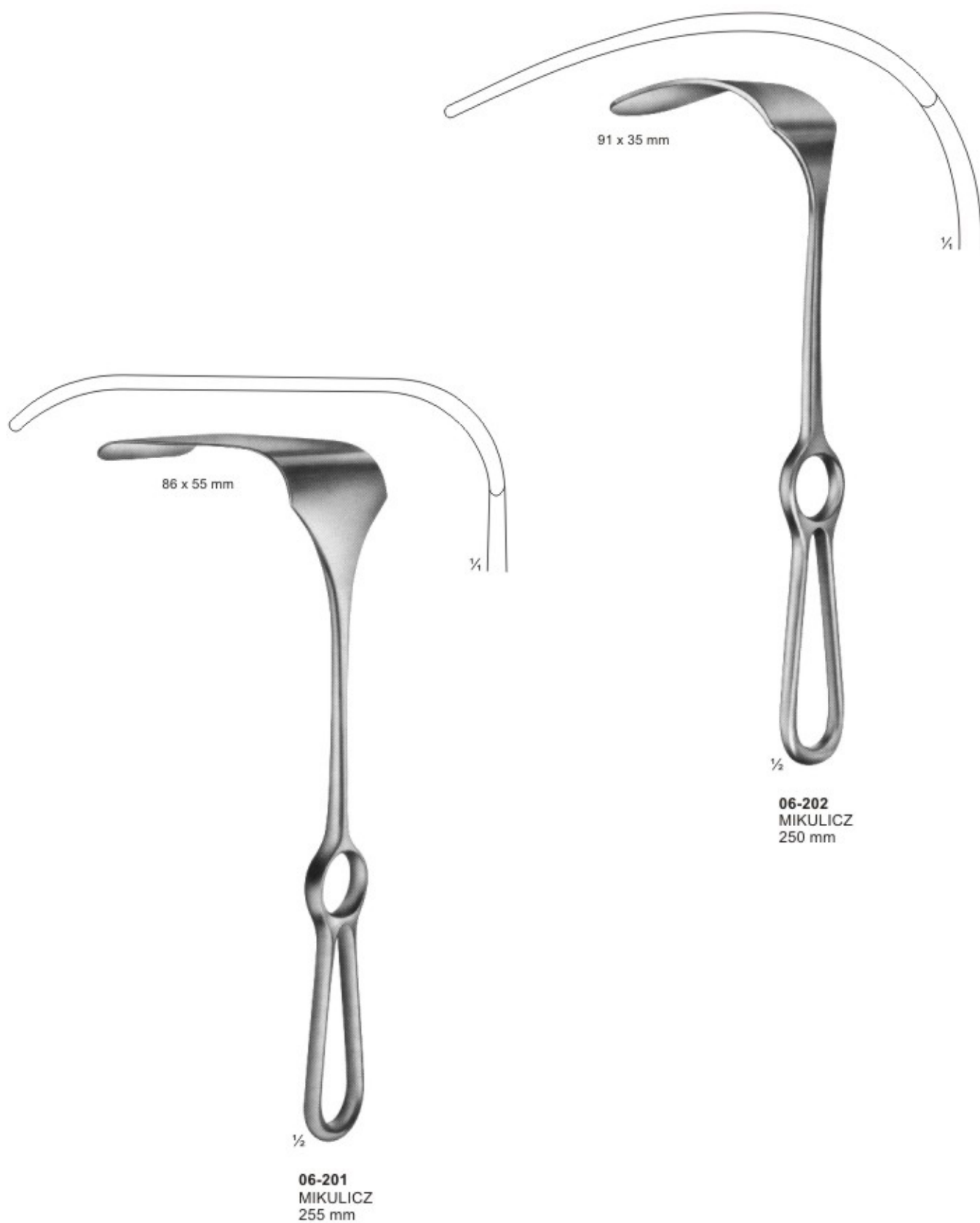

Retractors, Abdominal Retractors
Wundhaken, Bauchdeckenhaken

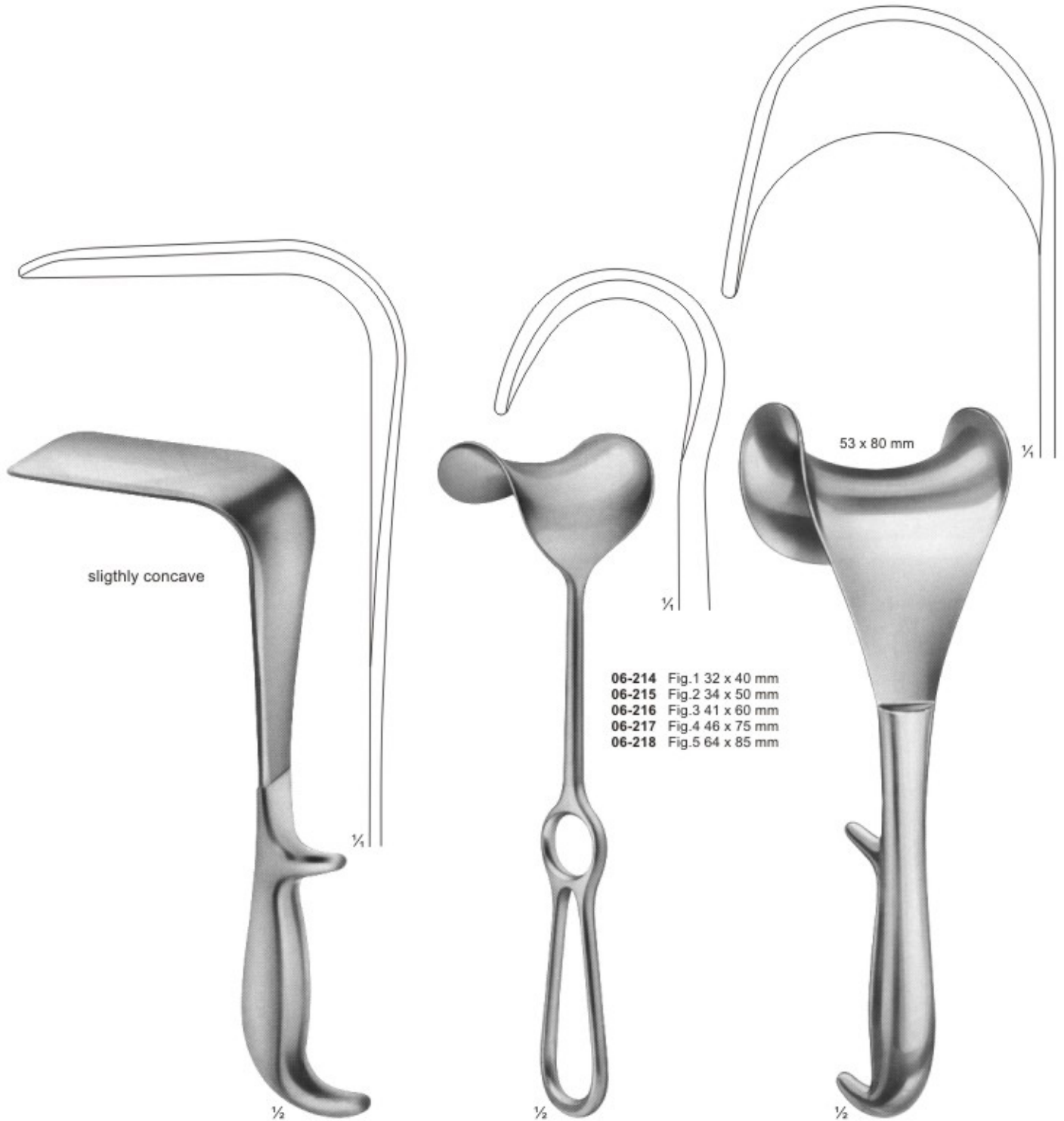

06-203 - 213
DOYEN
 240 mm

06-214 - 218
FRITSCH
 240 mm

06-219
DOYEN
 250 mm

	width of blades	35 mm, 45 mm, 60 mm
length of blades		
62 mm		06-203, 06-204, 06-205
92 mm		06-206, 06-207, 06-208
122 mm		06-209, 06-210, 06-211
160 mm		06-212, 06-213

Abdominal- and Intestinal Spatulas
Bauch- und Darmspatel

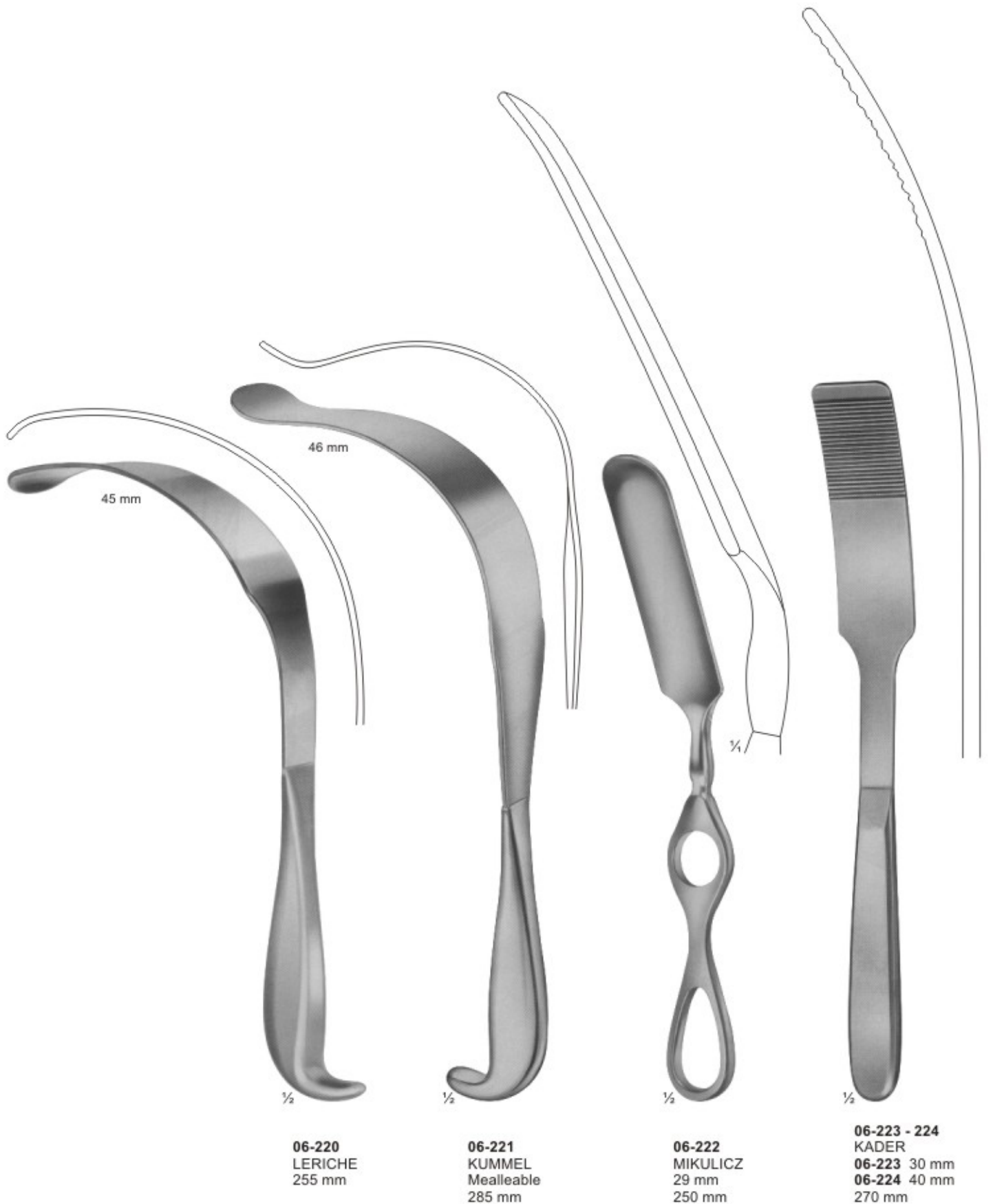

Self-Retaining Retractors Wundspreizer

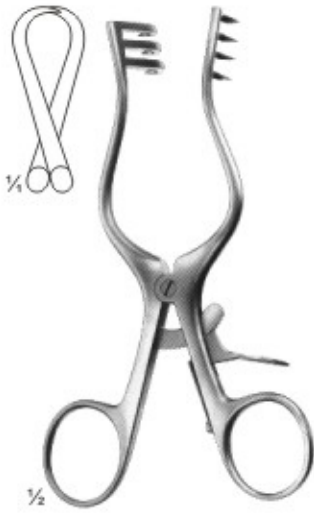

06-225
WEITLANER
sharp
130 mm

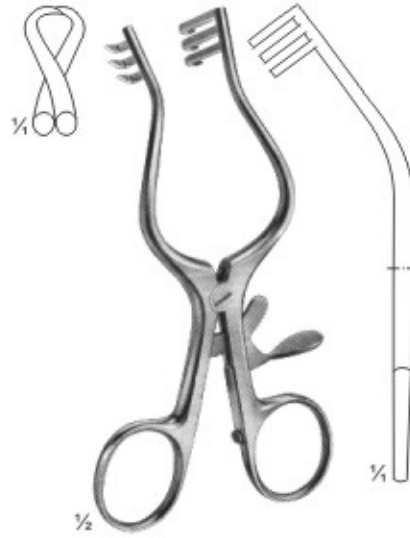

06-226
WULLSTEIN
sharp
130 mm

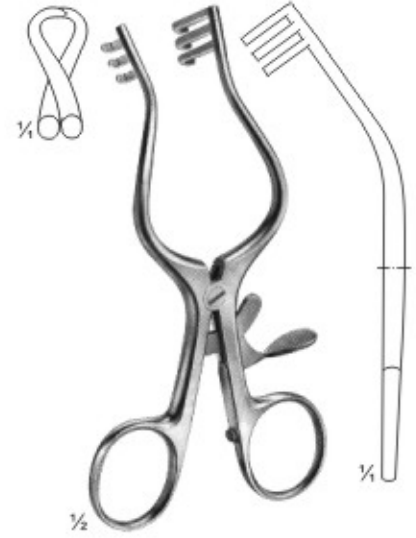

06-227
WULLSTEIN
blunt
130 mm



06-228
WEITLANER
sharp
165 mm



06-229
PLESTER
blunt
110 mm



06-230
PERKINS
130 mm



06-231
JOLL (FRIEDMAN)
 Thyroid- and vaginal retractor
 155 mm

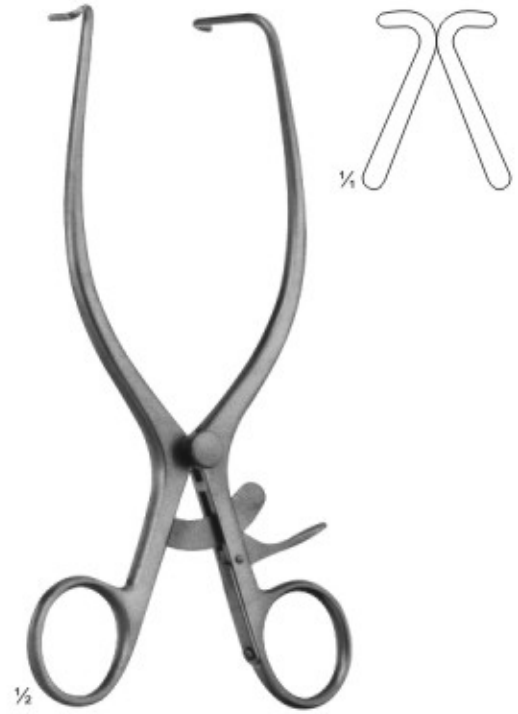

06-232
JACKSON BURROWS
 Retractor, blunt
 185 mm



06-233
GELPI
 Vaginal retractor
 135 mm

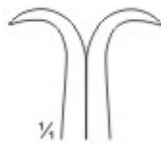

06-234
GELPI
 Skin- and vaginal retractor
 175 mm

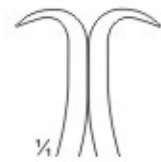

06-235
DE BAKEY
 Femur retractor
 145 mm

Lamina Spreaders
Wirbelkorperspreizer



06-236
CLOWARD
 155 mm



06-237
CLOWARD
 135 mm

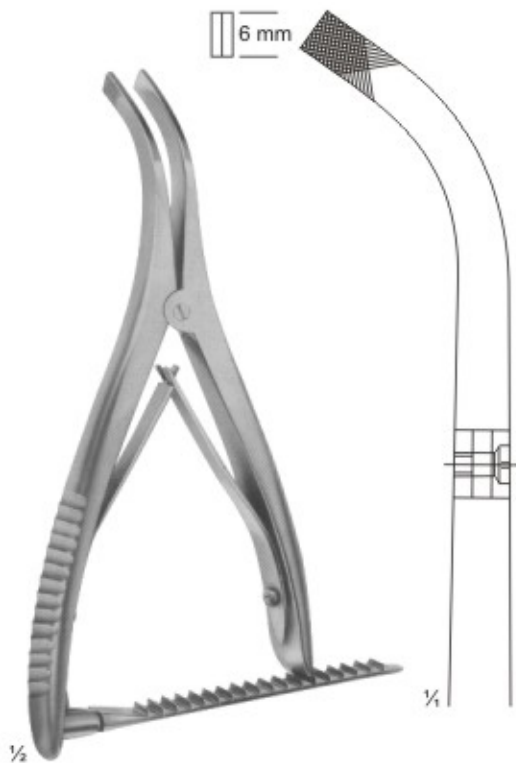

06-238
INGE
 170 mm

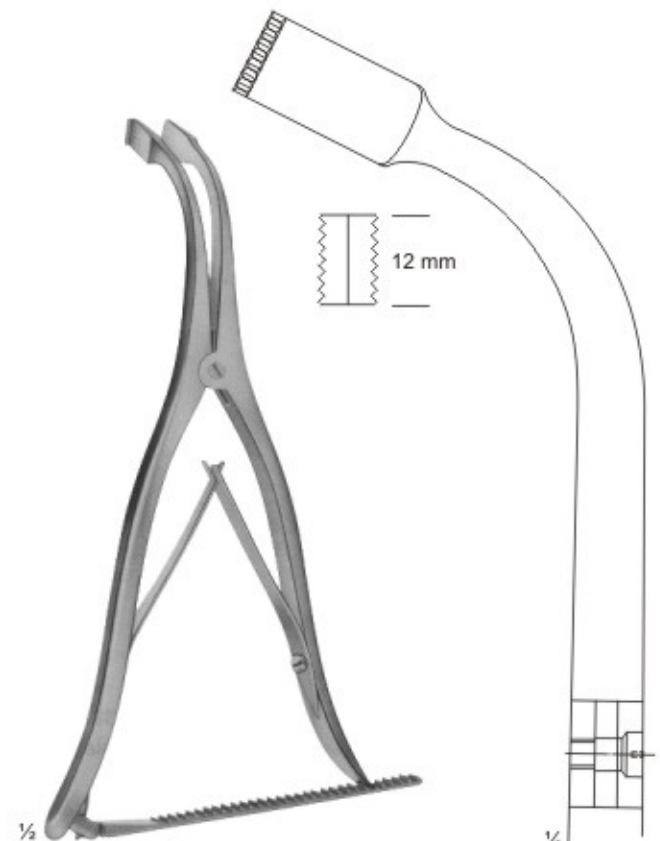

06-239
INGE
 275 mm

Abdominal Retractors Bauchdeckenhalter



06-240
GOSSET
Blades:38 mm deep

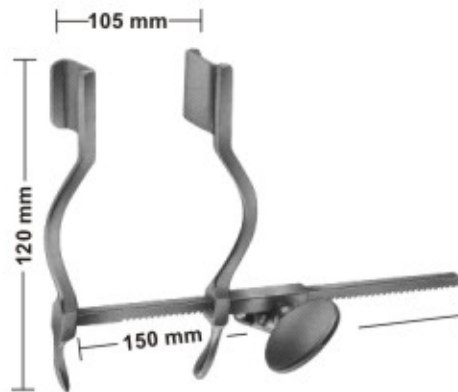

06-241
HERTZLER
Blades 20 X 25 mm

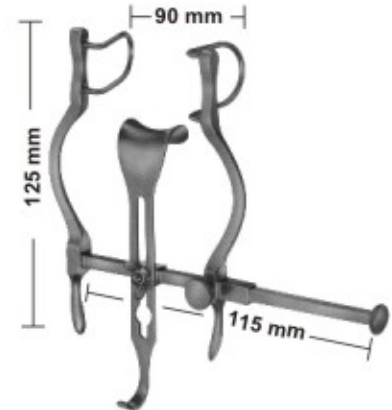

06-242
BALFOUR-BABY
Lateral blades 27 mm deep
Center blade 21x24 mm

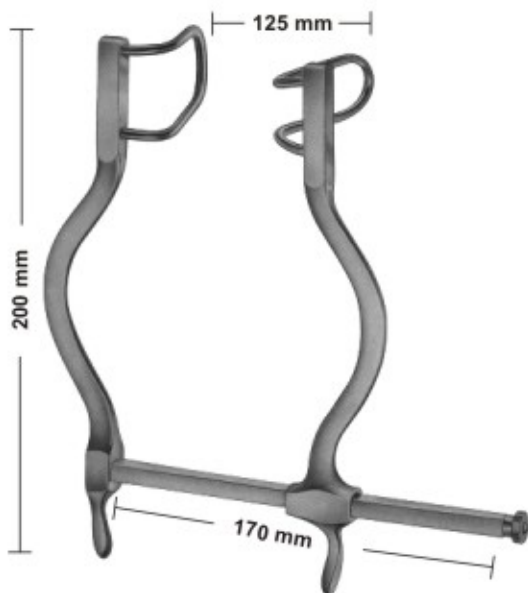

06-243
GOSSET
Blades:55mm deep

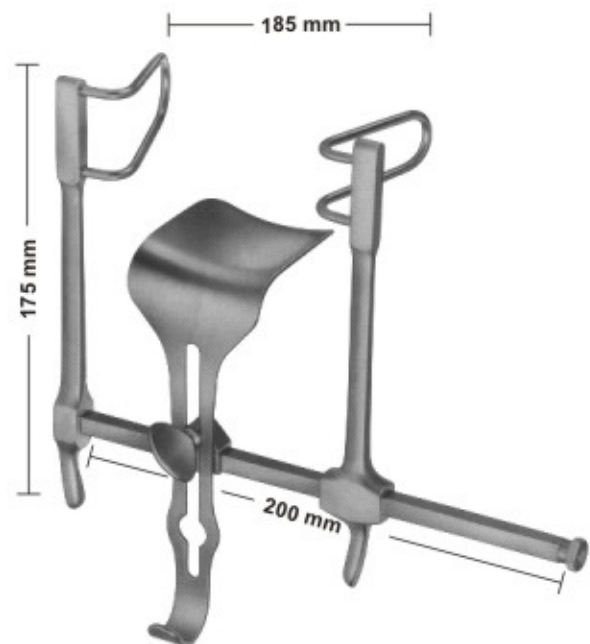

06-244
GOSSET
Lateral blades 58 mm deep
Center blade 59 x 57 mm

Abdominal Retractors Bauchdeckenhalter

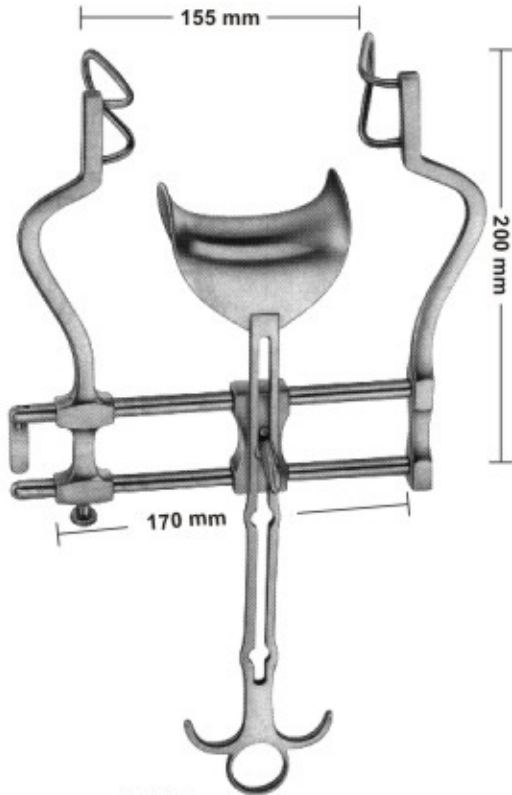

06-245
BALFOUR
Lateral blades 60 mm deep
Center blade 47 x 80 mm

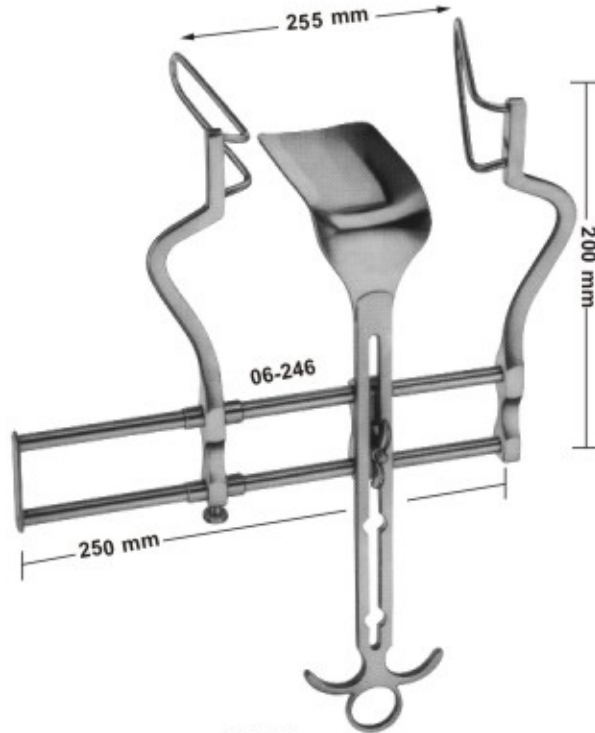

06-246
BALFOUR
Lateral blades 105 mm deep
Center blade 107x 59 mm



06-247
Center blade only
54x80 mm

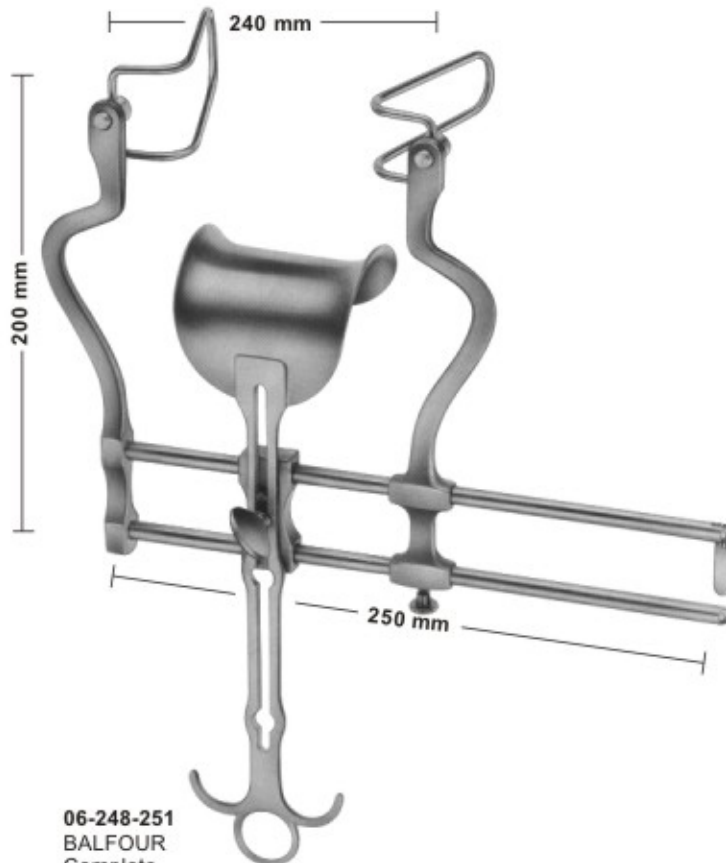

06-248-251
BALFOUR
Complete
Spreader only **06-248** **06-249** **06-250** **06-251**
Lateral blades 50 mm 60 mm 75 mm 90 mm
Center blade 47 x 80 mm 62x76 mm 80x80 mm 80x80 mm



Sales Unit of blades: PR = pair

- Lateral blades
- 06-252** 50 mm deep
- 06-253** 60 mm deep
- 06-254** 75 mm deep
- 06-255** 90 mm deep

Organ-, Tissue and Intestinal Grasping Forceps
Organ-, Gewebe- und Darmfaßzangen

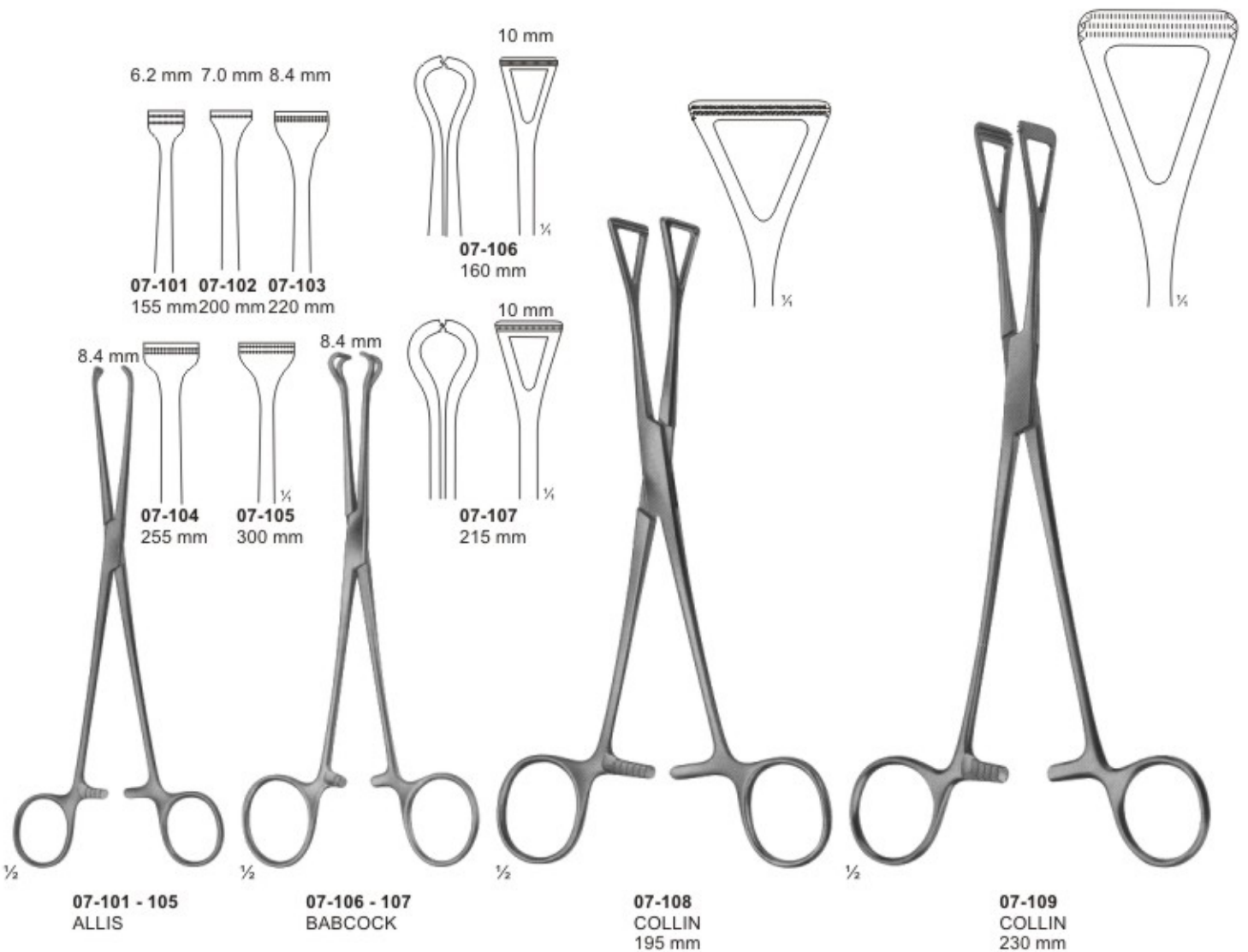

**Intestinal Clamps, soft elastic
Darmklemmen, weich federnd**



ATRAUMATA

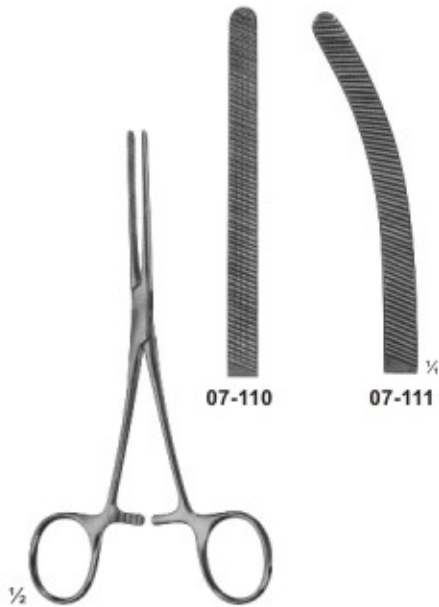

07-110 - 111
DOYEN
elastic
165 mm

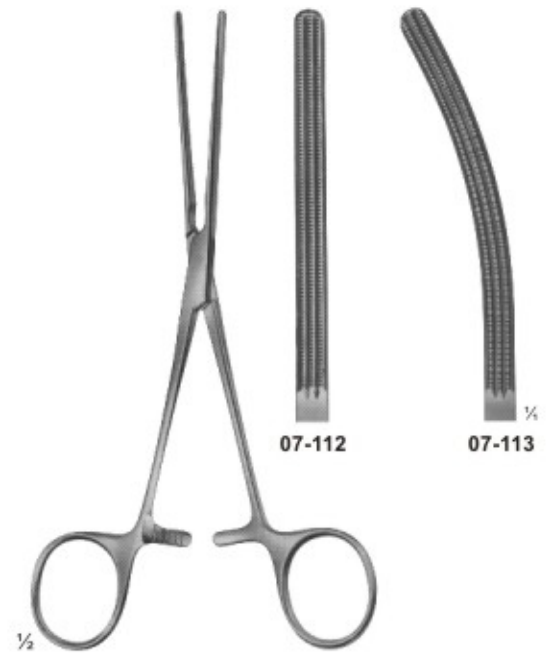

07-112 - 113
DOYEN
with elastic blades
170 mm

ATRAUMATA

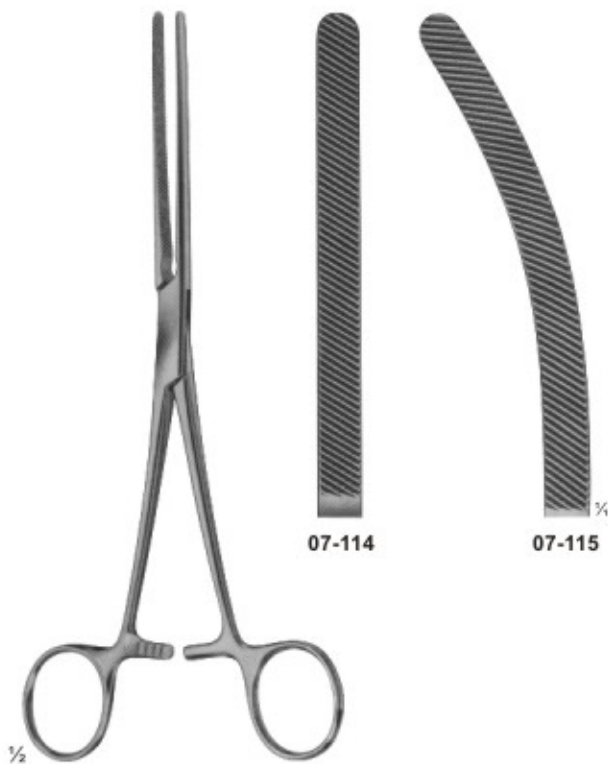

07-114 - 115
HARTMANN
with elastic blades
200 mm

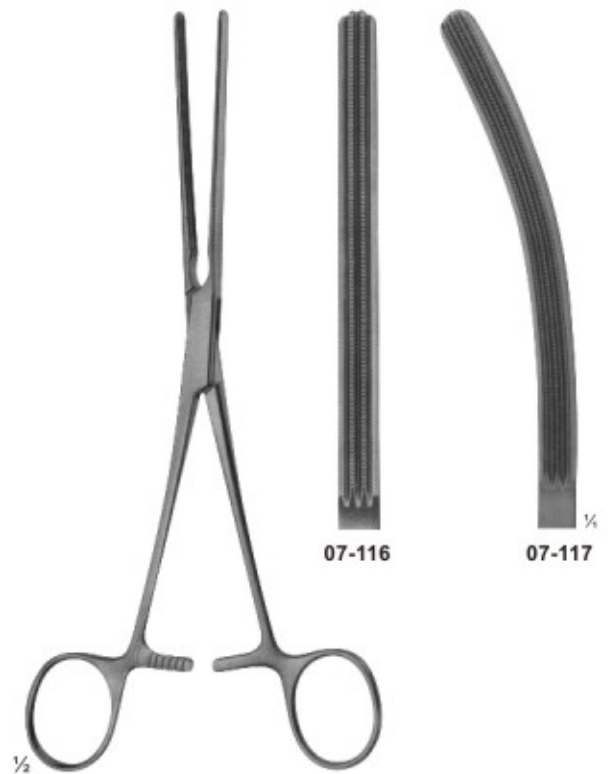

07-116 - 117
HARTMANN
with elastic blades
200 mm

Intestinal and Pylorus Clamps Dram- und Magenquetschklemmen



1/2
07-118
PAYR
Intestinal clamp
light pattern,
for children
180 mm

1/2
07-119
PAYR
200 mm

1/2
07-120
PAYR
275 mm

1/2
07-121
PAYR
Pylorus clamp
315 mm

ATRAUMATA
Sigmoid Anastomosis Forceps
Rektum-Anastomosenklemmen

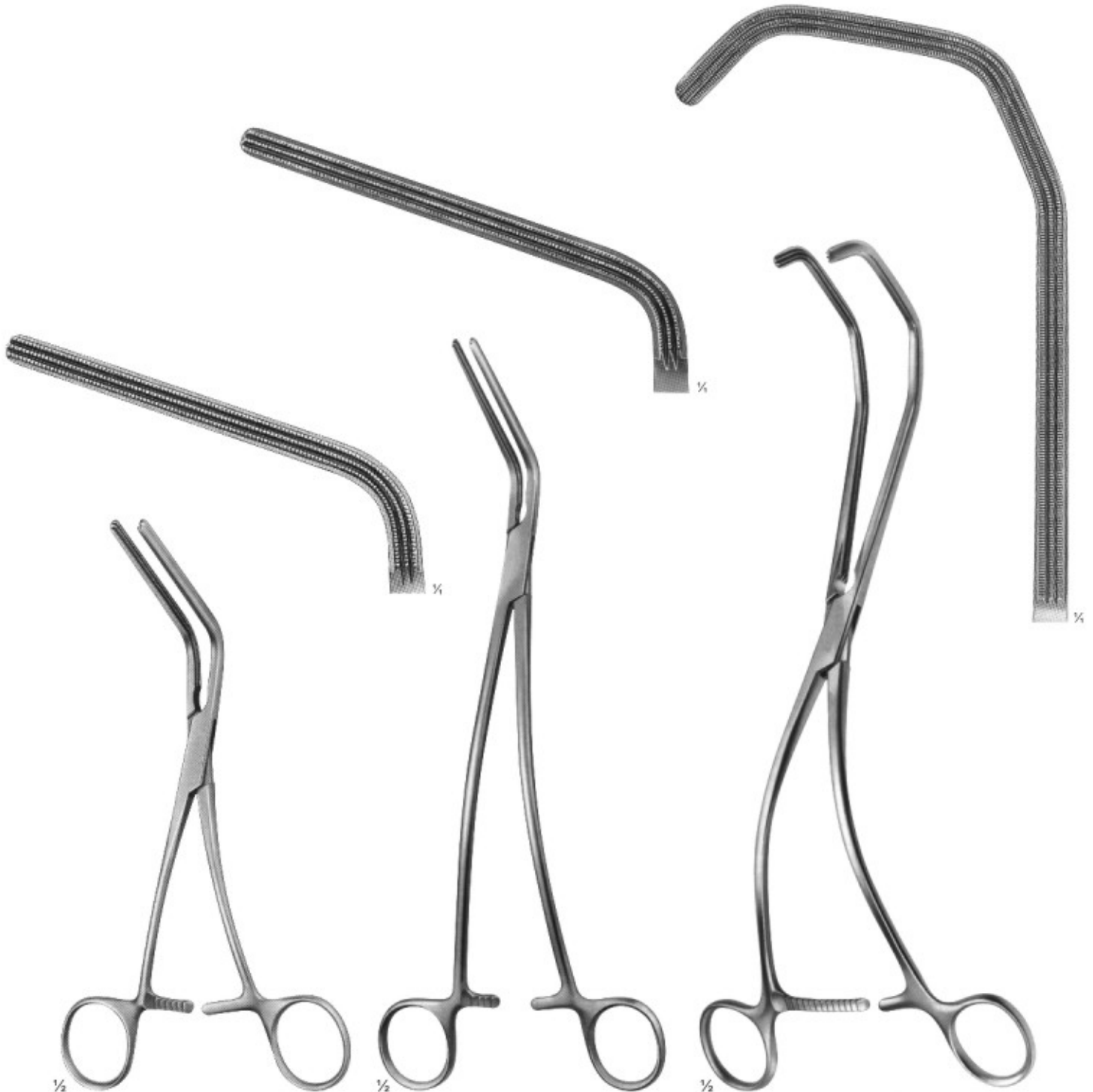

07-222
MORRIS
175 mm

07-223
DE BAKY
(MORRIS modif.)
240 mm

07-224
KERSTING
270 mm

Rectal Specula Mastdarm-Rektum-Spekula

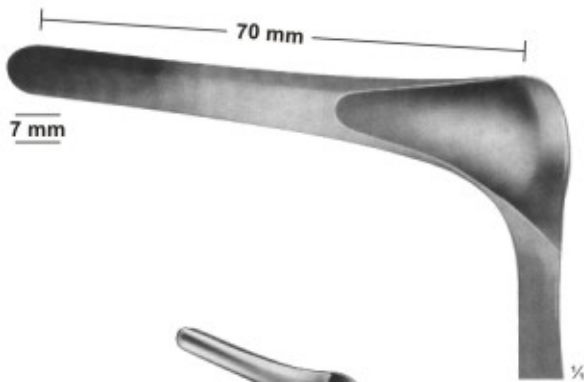

08-101
KILLIAN
for children
145 mm



08-102
SIMS
160 mm



08-103
SIMS
160 mm

Anuscopes-Sphincteroscopes
Anuskope-Sphinkteroskope



08-104
IVES-FANSLER
Anuscops
145 mm
Ø24mm



08-105
KELLY
Sphincteroscope
160 mm
Ø21mm



08-106
KELLY
Sphincteroscope
160 mm
Ø27mm

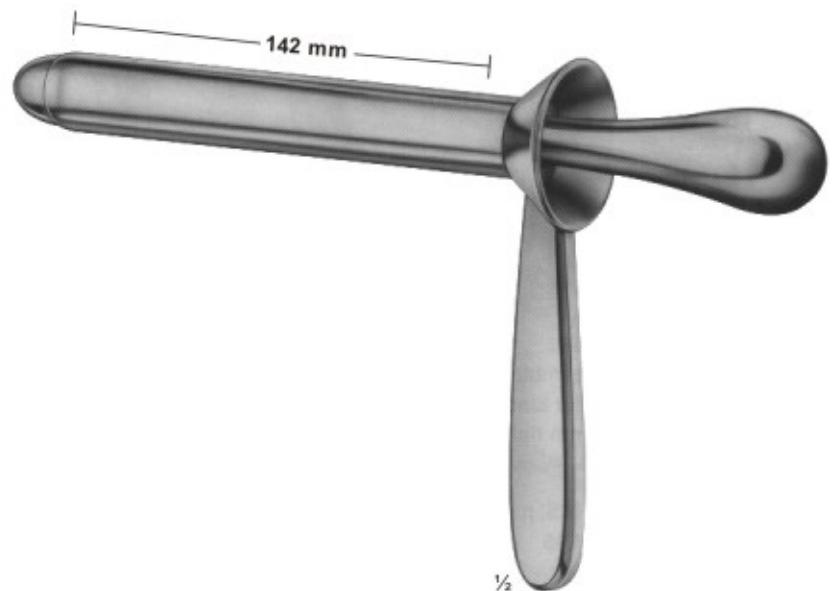

08-107
KELLY
Proctoscope
140 mm
Ø22mm

Biopsy forceps for rectum Biopsiezangen für Rektum

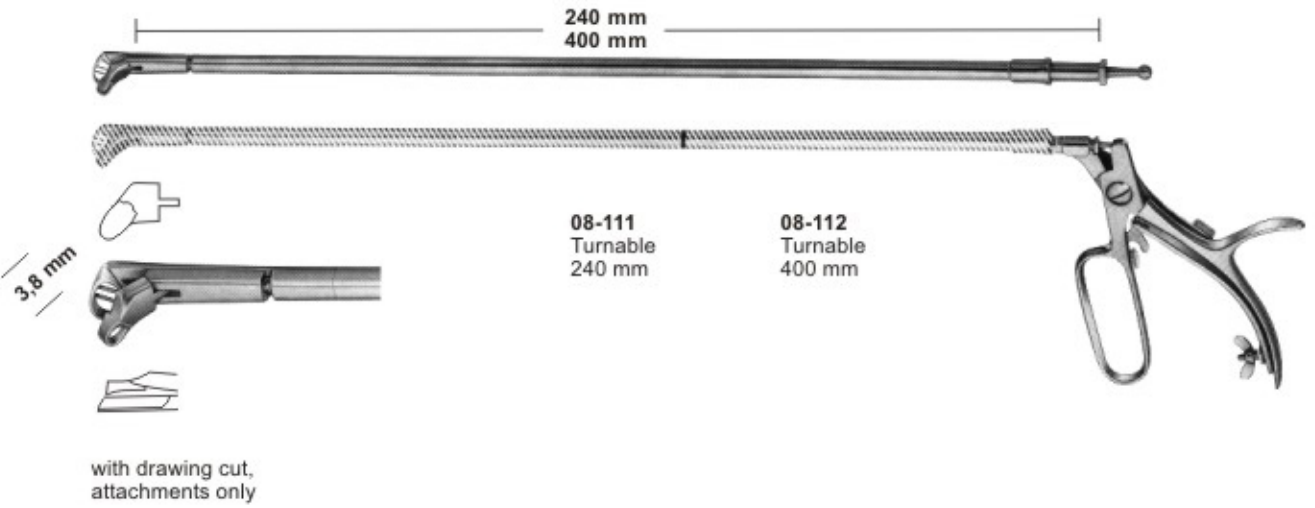
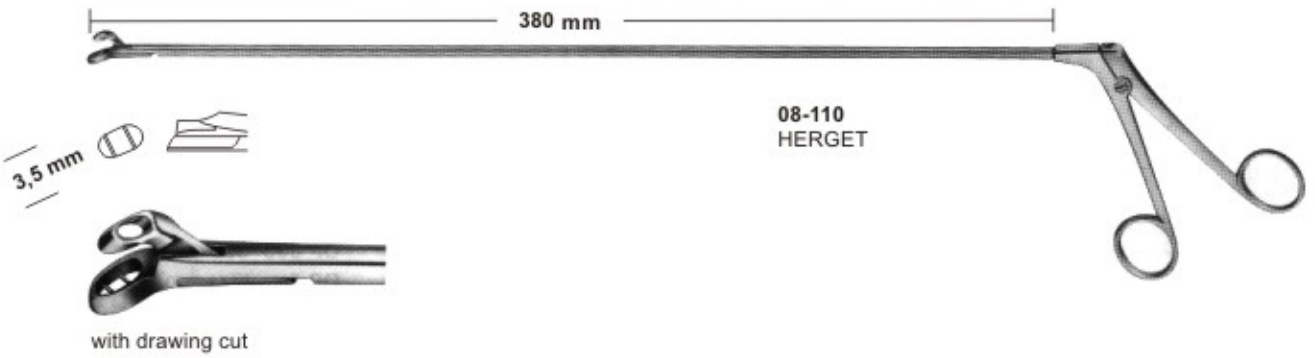
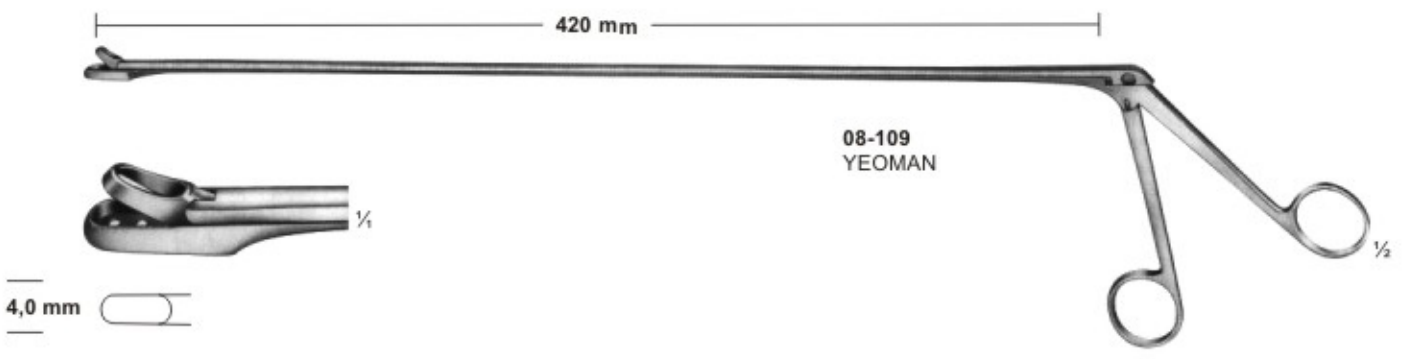
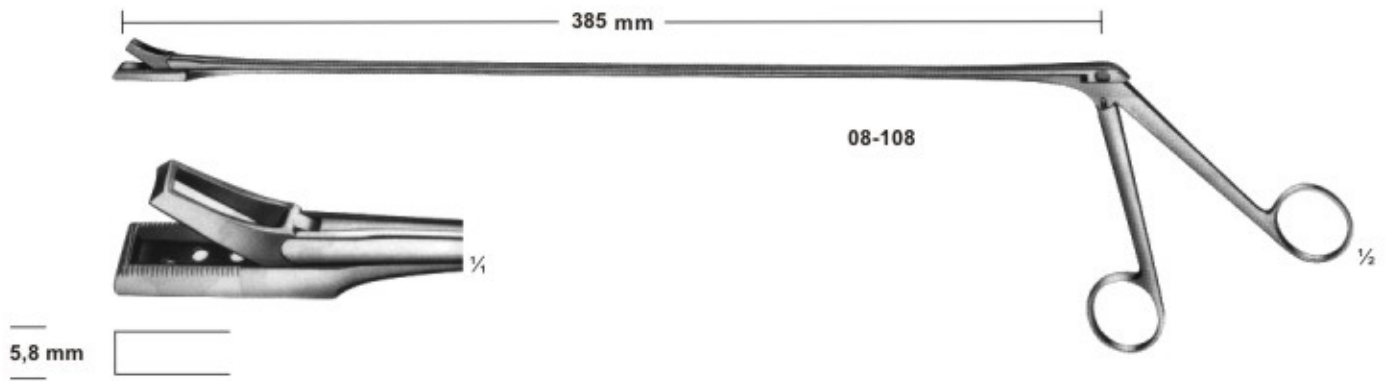

ATRAUMATA

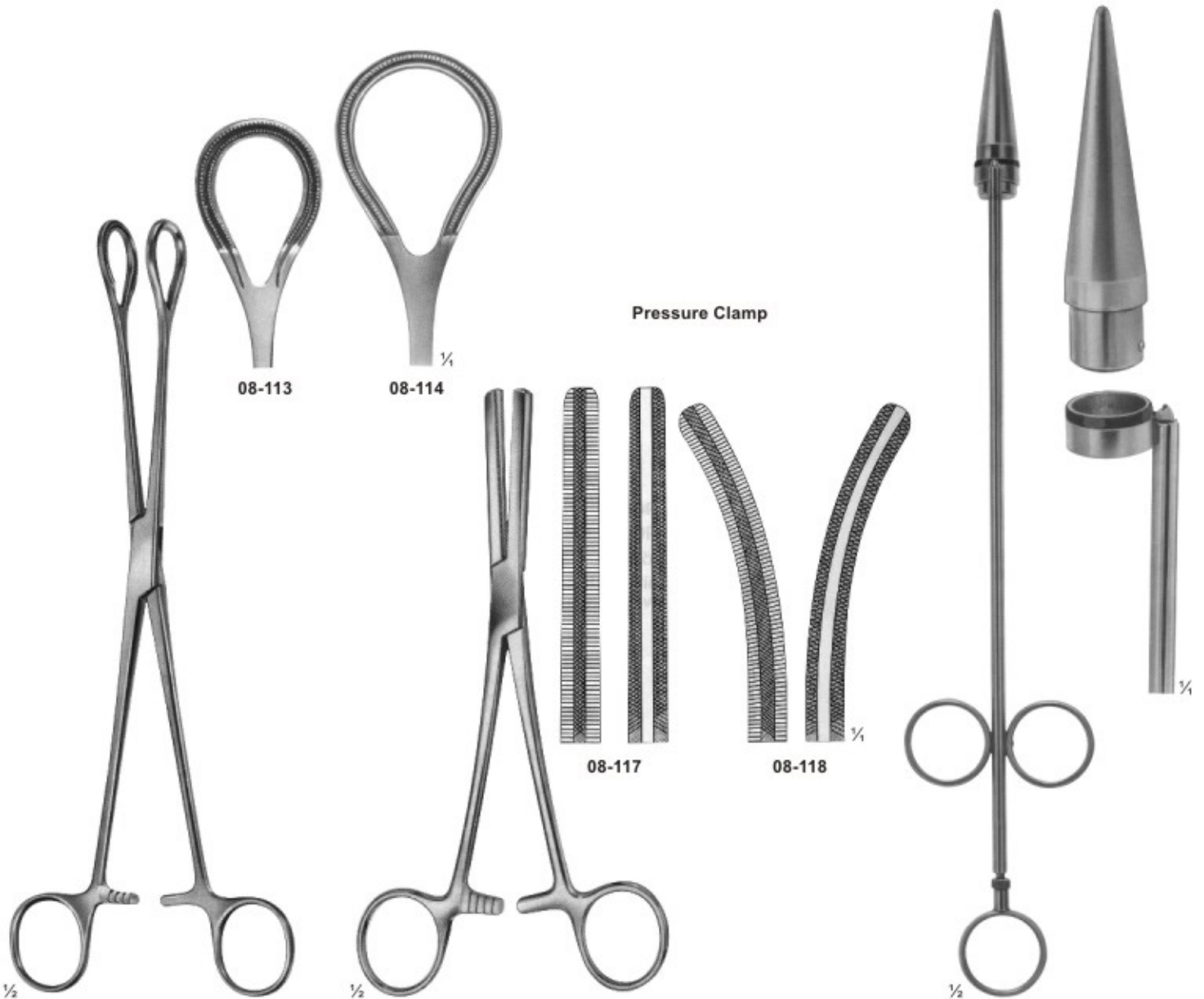

08-113 - 114
250 mm
08-114
270 mm

08-115 - 116
FERGUSSON
200 mm

08-119
RUDD
Haemorrhoidal ligator
with loading
attachment and 100
ligature rubber rings
315 mm

Gall Duct Forceps Gallenkanal-Klemmzangen



08-120
LOWER
180 mm



08-121
LAHEY (SWEET)
190 mm



08-123
LAHEY
220 mm



08-124
DESJARDINS
Gall duct-and cystic forceps
210 mm



08-125
NISSEN
Gall duct-and cystic forceps
215 mm

Gall Duct Dilators and Gall Stone Scoops

Gallengangdilatoren und Gallensteinloffel

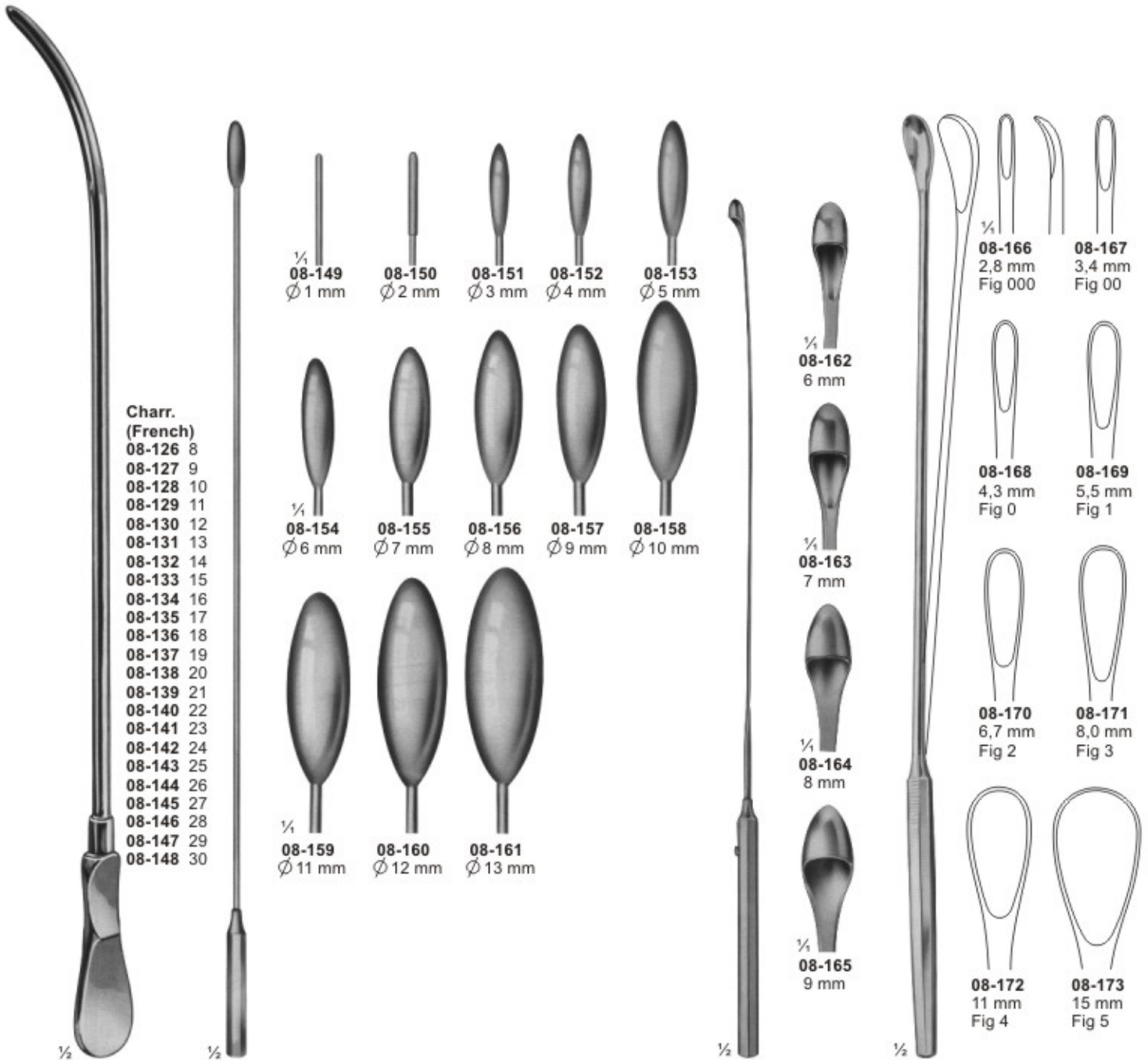

**Charr.
(French)**
 08-126 8
 08-127 9
 08-128 10
 08-129 11
 08-130 12
 08-131 13
 08-132 14
 08-133 15
 08-134 16
 08-135 17
 08-136 18
 08-137 19
 08-138 20
 08-139 21
 08-140 22
 08-141 23
 08-142 24
 08-143 25
 08-144 26
 08-145 27
 08-146 28
 08-147 29
 08-148 30

$\frac{1}{4}$ 08-149 \varnothing 1 mm 08-150 \varnothing 2 mm 08-151 \varnothing 3 mm 08-152 \varnothing 4 mm 08-153 \varnothing 5 mm
 $\frac{1}{4}$ 08-154 \varnothing 6 mm 08-155 \varnothing 7 mm 08-156 \varnothing 8 mm 08-157 \varnothing 9 mm 08-158 \varnothing 10 mm
 $\frac{1}{4}$ 08-159 \varnothing 11 mm 08-160 \varnothing 12 mm 08-161 \varnothing 13 mm

$\frac{1}{4}$ 08-162 6 mm $\frac{1}{4}$ 08-163 7 mm $\frac{1}{4}$ 08-164 8 mm $\frac{1}{4}$ 08-165 9 mm
 $\frac{1}{4}$ 08-166 2,8 mm Fig 000 08-167 3,4 mm Fig 00
 08-168 4,3 mm Fig 0 08-169 5,5 mm Fig 1
 08-170 6,7 mm Fig 2 08-171 8,0 mm Fig 3
 08-172 11 mm Fig 4 08-173 15 mm Fig 5

08-126 - 148
DITTEL
 Metall bougies and dilating sounds, stiff 345 mm

08-149 - 161
BAKES
 Common bile duct dilators, malleable
 08-149-153 315 mm
 08-154-161 320 mm

08-162 - 165
DESJARDINS
 Probe and catch with flexible shaft 300 mm

08-166 - 173
LUER-KOERTE modif
 with malleable shaft 310 mm

Gall Stone Forceps Gallensteinzangen

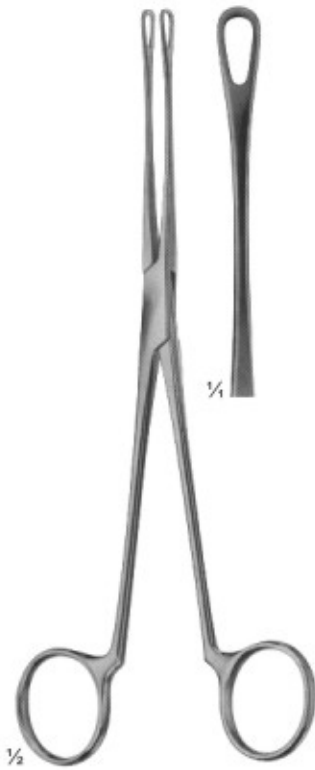

08-174
BLAKE
205 mm

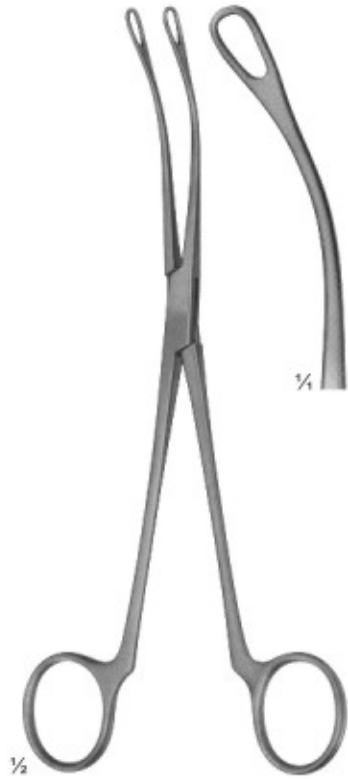

08-175
BLAKE
205 mm

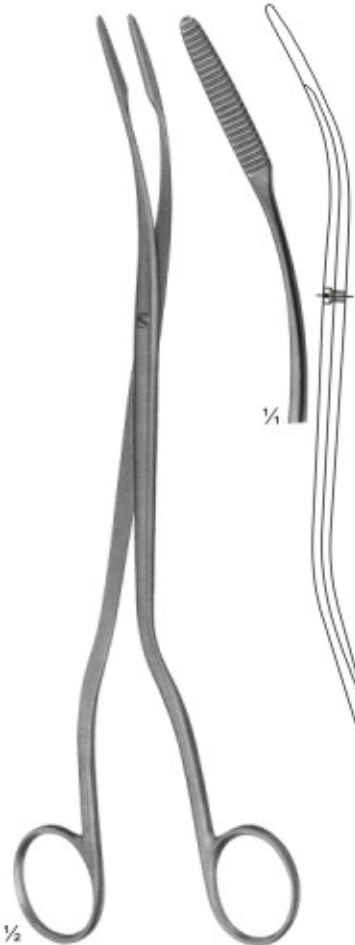

08-176
CZERNY
245 mm



08-177 - 180
DESJARDINS
225 mm



08-181 - 182
DESJARDINS
Extremely delicate patterns

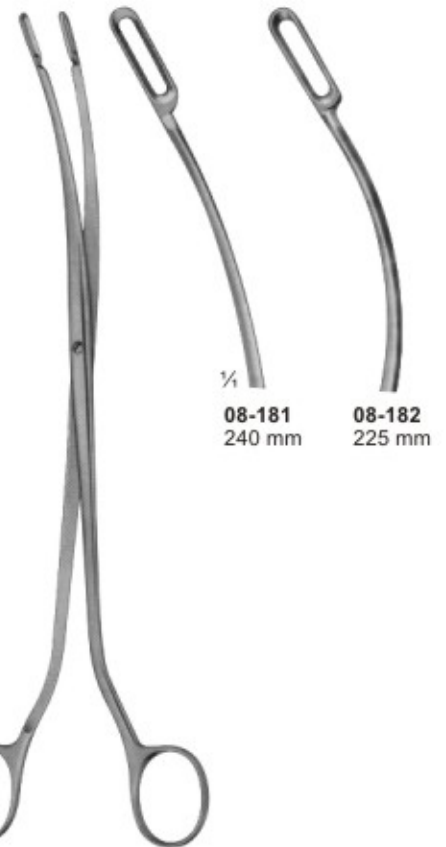

08-181
240 mm **08-182**
225 mm

ATRAUMATA

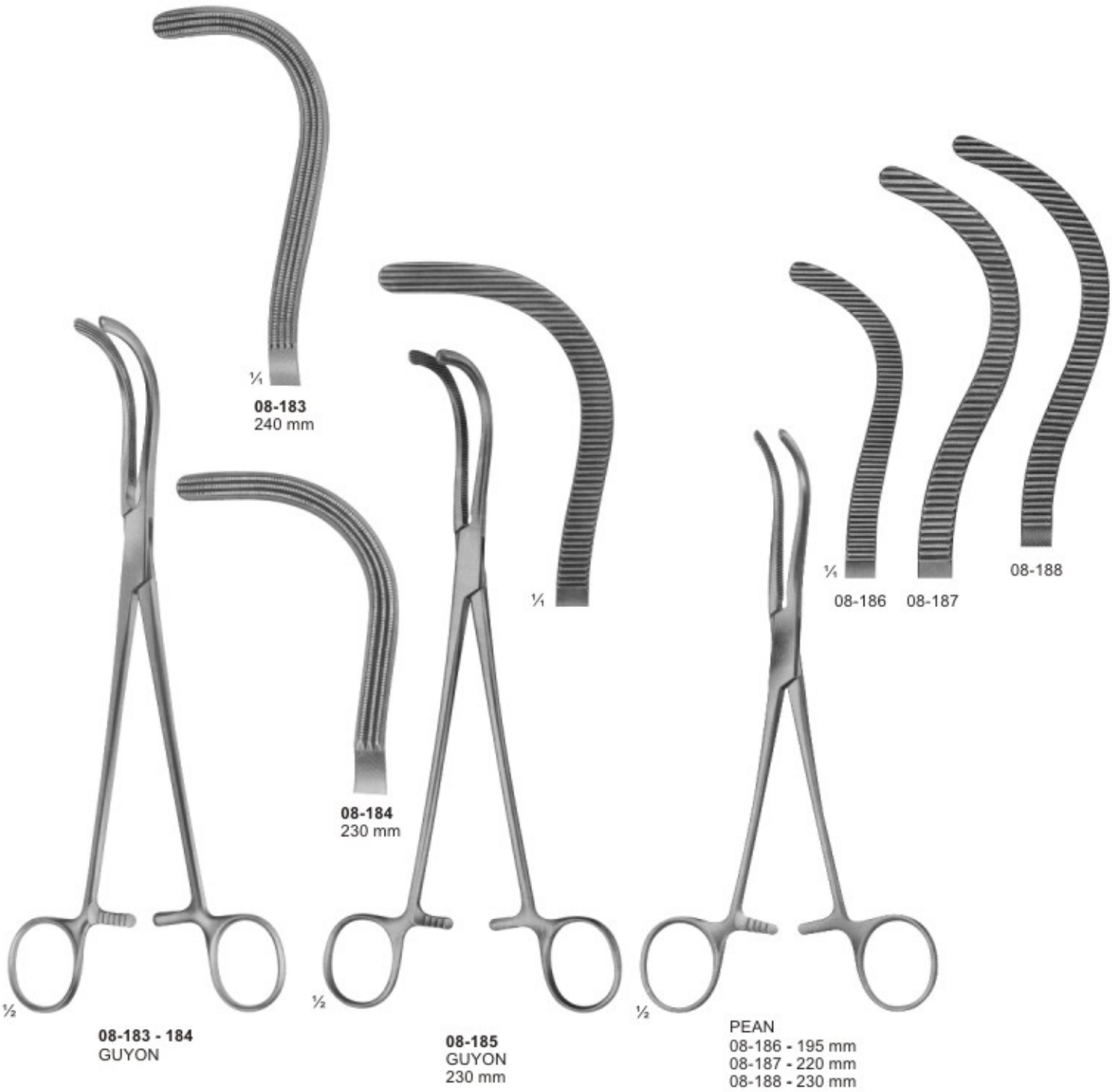

Kidney Stone Forceps Nierensteinzangen



08-189



08-190



08-191



1/4
08-192



08-193



08-194



1/4
08-195



1/2

08-189 - 192
RANDALL
225 mm



1/2

08-193 - 195
RANDALL
190 mm

Bladder Retractors Blasenwundspreizer

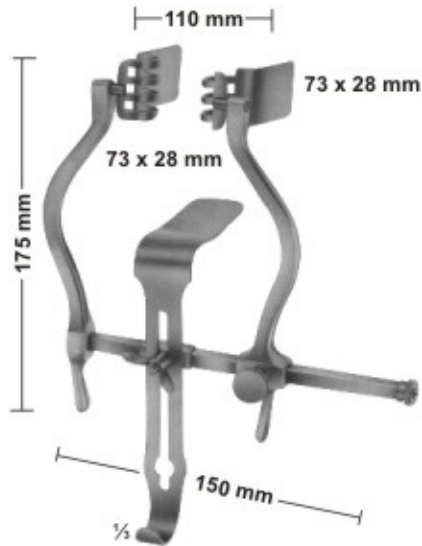

09-101
JUDD-MASSON
Bladder-and suprapubic
retractor

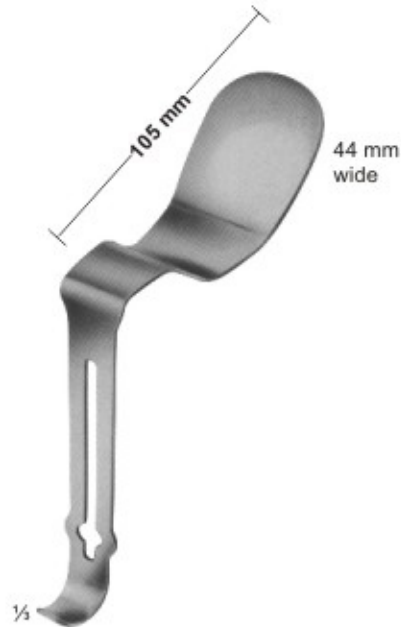

09-102
MILLIN
Center bladder for
retro pubic prostatectomy

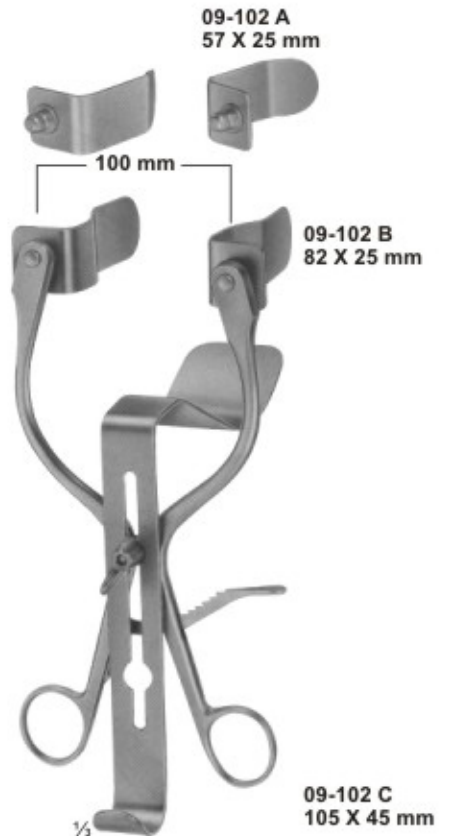

09-103
MILLIN
Bladder retractor, complete
105X45 mm



09-104
LEGUEU
Bladder retractor
Center blade
80 x 31 mm

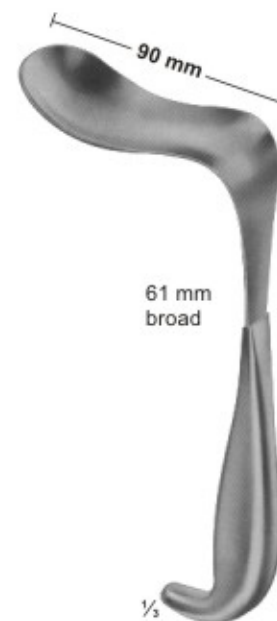

09-105
KOCHER
Bladder spatula
235 mm

Trocars Trocare





Luer Lock

09-106
KLIMA ROSEGGER
35 X 1,8 mm
Sternal puncture needle

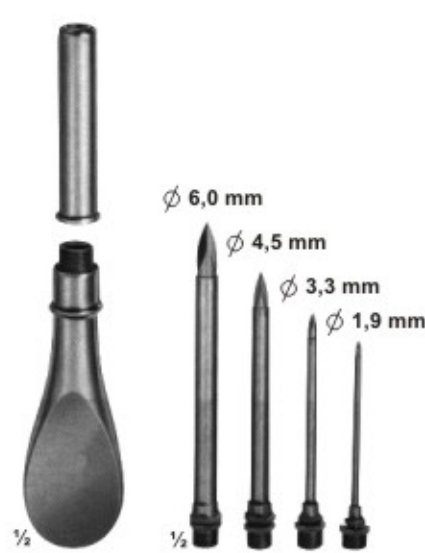

ϕ 6,0 mm
 ϕ 4,5 mm
 ϕ 3,3 mm
 ϕ 1,9 mm

09-107
Universal trocar
with 4 tips



80 mm

NELSON

09-108 - 112
Inside diam. Outside diam
09-108 2,2 mm 3,0 mm
09-109 3,0 mm 4,0 mm
09-110 4,0 mm 5,0 mm
09-111 5,0 mm 6,0 mm
09-112 5,5 mm 6,5 mm
for hydrocele and abdominal puncture



80 mm

09-113 - 116
Inside dime. Outside dime
09-113 2,2 mm 3,0 mm
09-114 3,0 mm 4,0 mm
09-115 4,0 mm 5,0 mm
09-116 5,0 mm 6,0 mm
for abdominal puncture,
with stop-cock and lateral
drain

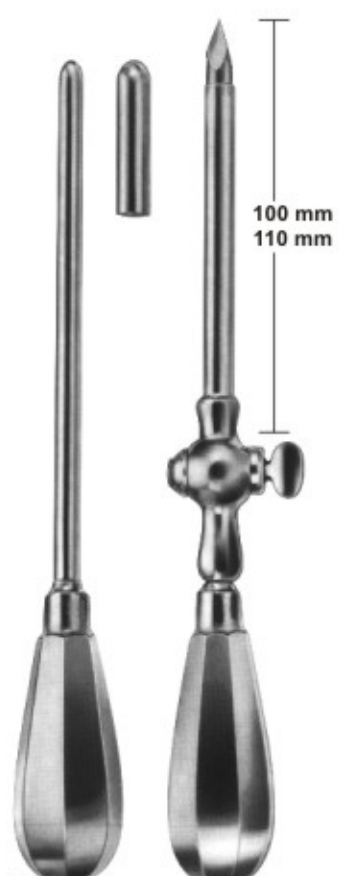

100 mm
110 mm

09-117 - 118
Inside diam. Outside diam
09-117 6,5 mm 8,0 mm
09-118 9,0 mm 10,0 mm
Epyema trocar
BUELEU

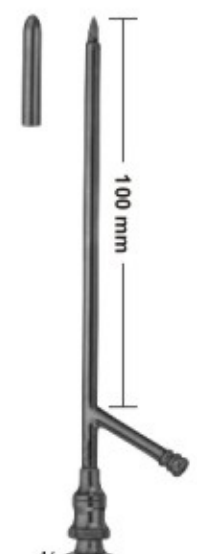

100 mm

09-119 - 122
Inside diam. Outside diam
09-119 3,0 mm 4,0 mm
09-120 3,6 mm 4,6 mm
09-121 4,3 mm 5,3 mm
09-122 5,0 mm 6,0 mm
Gall bladder trocars
OCHSNER



Record Cone1

09-123
PIERCE
Antrum trocar
 ϕ 4,0 mm



Luer - Lock
Cone

09-124
COAKLEY
Antrum trocar
 ϕ 3,0 mm

**Vaginal Specula- Sets, upper and lower blades
Scheidenspekula-Satze, obere und untere Blätter**

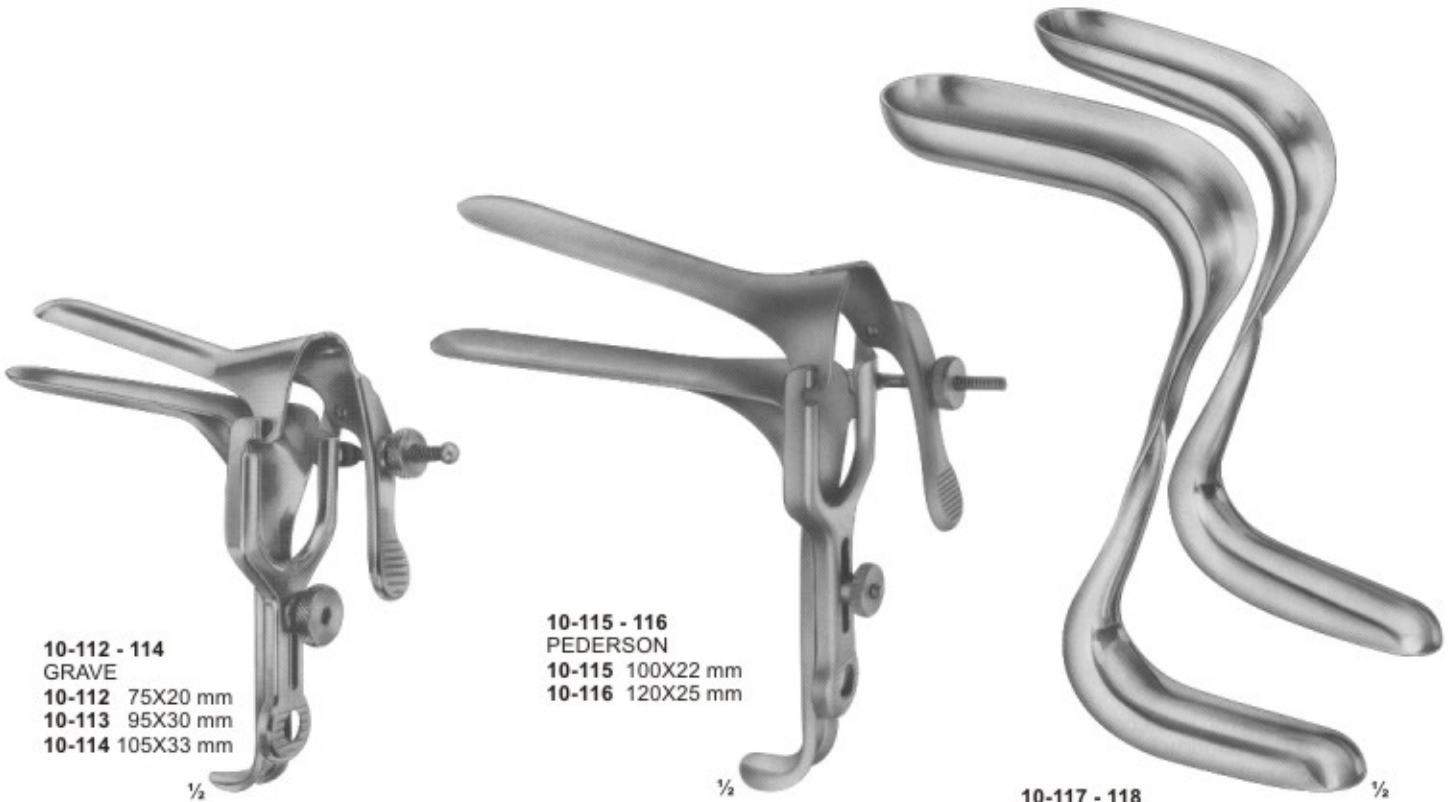

**10-112 - 114
GRAVE**
10-112 75X20 mm
10-113 95X30 mm
10-114 105X33 mm

**10-115 - 116
PEDERSON**
10-115 100X22 mm
10-116 120X25 mm

**10-117 - 118
BRIESKY**
10-117 72X25 mm / 77X30 mm 140 mm
10-118 75X30 mm / 92X38 mm 170 mm

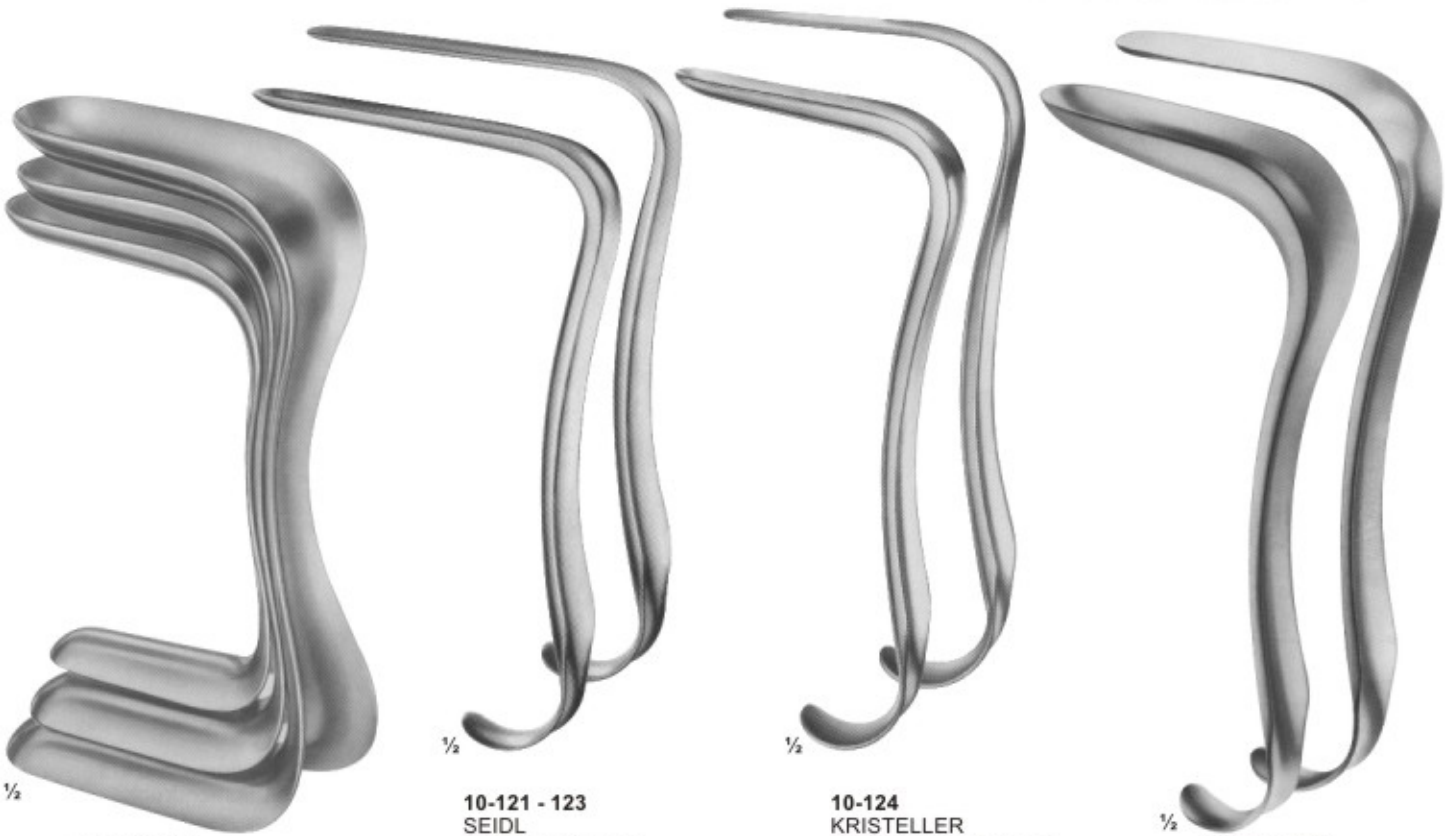

**10-119 - 120
SIMS**
70 X 26 mm / 75 X 30 mm
75 X 30 mm / 80 X 35 mm
80 X 36 mm / 90 X 40 mm
175 mm

**10-121 - 123
SEIDL**
10-121 80X8 mm
10-122 80X10 mm
10-123 90X14 mm
For children and infants
170 mm

**10-124
KRISTELLER**
70X15 mm, (170 mm)
For children

**10-125 - 127
KRISTELLER**
10-125 70X27 mm
10-126 75X30 mm
10-127 90X36 mm
175 mm

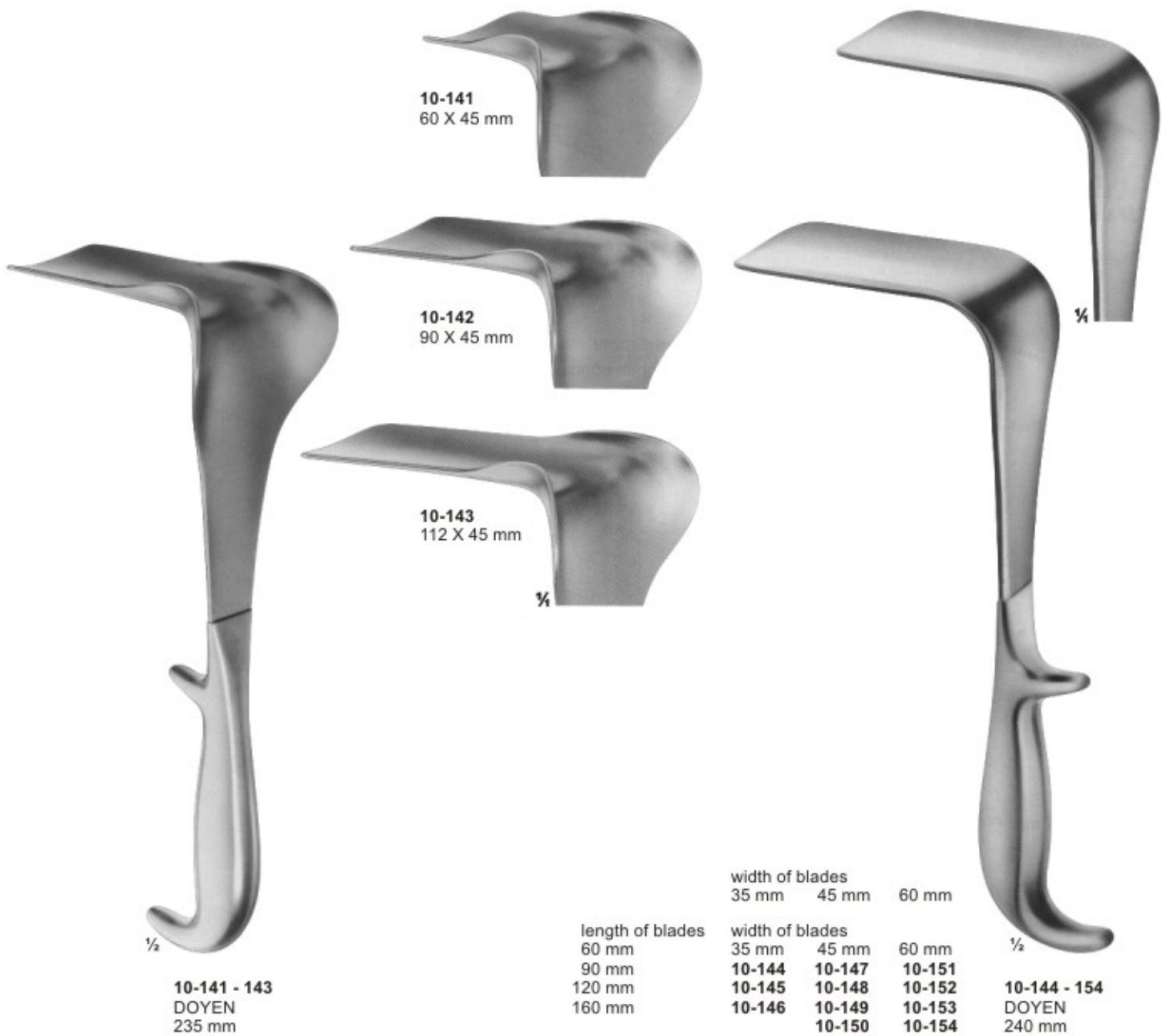

10-141
60 X 45 mm

10-142
90 X 45 mm

10-143
112 X 45 mm

1/2

10-141 - 143
DOYEN
235 mm

length of blades
60 mm
90 mm
120 mm
160 mm

width of blades
35 mm 45 mm 60 mm

width of blades
35 mm 45 mm 60 mm
10-144 10-147 10-151
10-145 10-148 10-152
10-146 10-149 10-153
10-150 10-154

1/4

1/2

10-144 - 154
DOYEN
240 mm

Vaginal Retractors Vulva-Spreizer



1/2
10-155
JOLL (FRIEDMAN)
155 mm



1/2
10-156
RICHTER
170 mm



1/2
10-157
GELPI
135 mm



1/2
10-158
GELPI
175 mm

Uterine Dilators Uterus-Dilatatoren



1/2

11-101 - 143
HEGAR
with very conical point
185 mm

11-101	1	mm	11-123	23	mm
11-102	2	mm	11-124	24	mm
11-103	3	mm	11-125	25	mm
11-104	4	mm	11-126	26	mm
11-105	5	mm	11-127	1	1/2mm
11-106	6	mm	11-128	2	1/2mm
11-107	7	mm	11-129	3	1/2mm
11-108	8	mm	11-130	4	1/2mm
11-109	9	mm	11-131	5	1/2mm
11-110	10	mm	11-132	6	1/2mm
11-111	11	mm	11-133	7	1/2mm
11-112	12	mm	11-134	8	1/2mm
11-113	13	mm	11-135	9	1/2mm
11-114	14	mm	11-136	10	1/2mm
11-115	15	mm	11-137	11	1/2mm
11-116	16	mm	11-138	12	1/2mm
11-117	17	mm	11-139	13	1/2mm
11-118	18	mm	11-140	14	1/2mm
11-119	19	mm	11-141	15	1/2mm
11-120	20	mm	11-142	16	1/2mm
11-121	21	mm	11-143	17	1/2mm
11-122	22	mm			



1/2

11-144 - 152
HEGAR
205 mm

11-144	1+2	mm
11-145	3+4	mm
11-146	5+6	mm
11-147	7+8	mm
11-148	9+10	mm
11-149	11+12	mm
11-150	13+14	mm
11-151	15+16	mm
11-152	17+18	mm

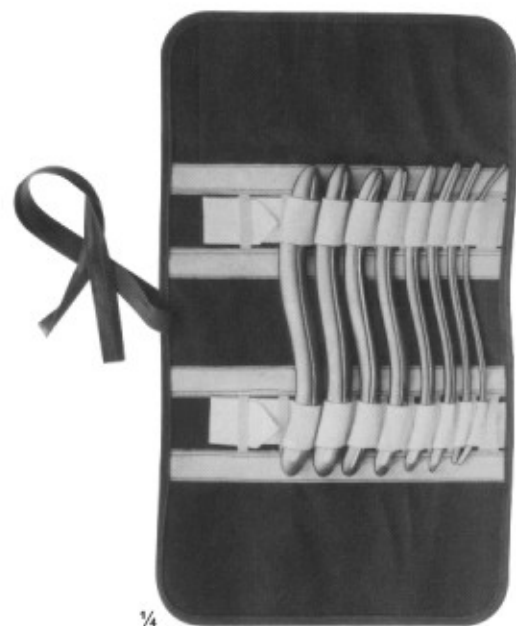

1/4

11-153
HEGAR
Uterine dilator set, in canvas
roll with 8 dilators.

Uterine Probes Uterussonden



11-154
MAYO
malleable
330 mm



11-155
SIMS
malleable
330 mm



11-156
MARTIN
330 mm



11-157
SIMPSON
malleable
silver-plated
290 mm



11-158
BRAUN
Uterine
depressor
270 mm



11-159
Cotton
applicator
270 mm

Uterine Dressing Forceps Tamponzangen

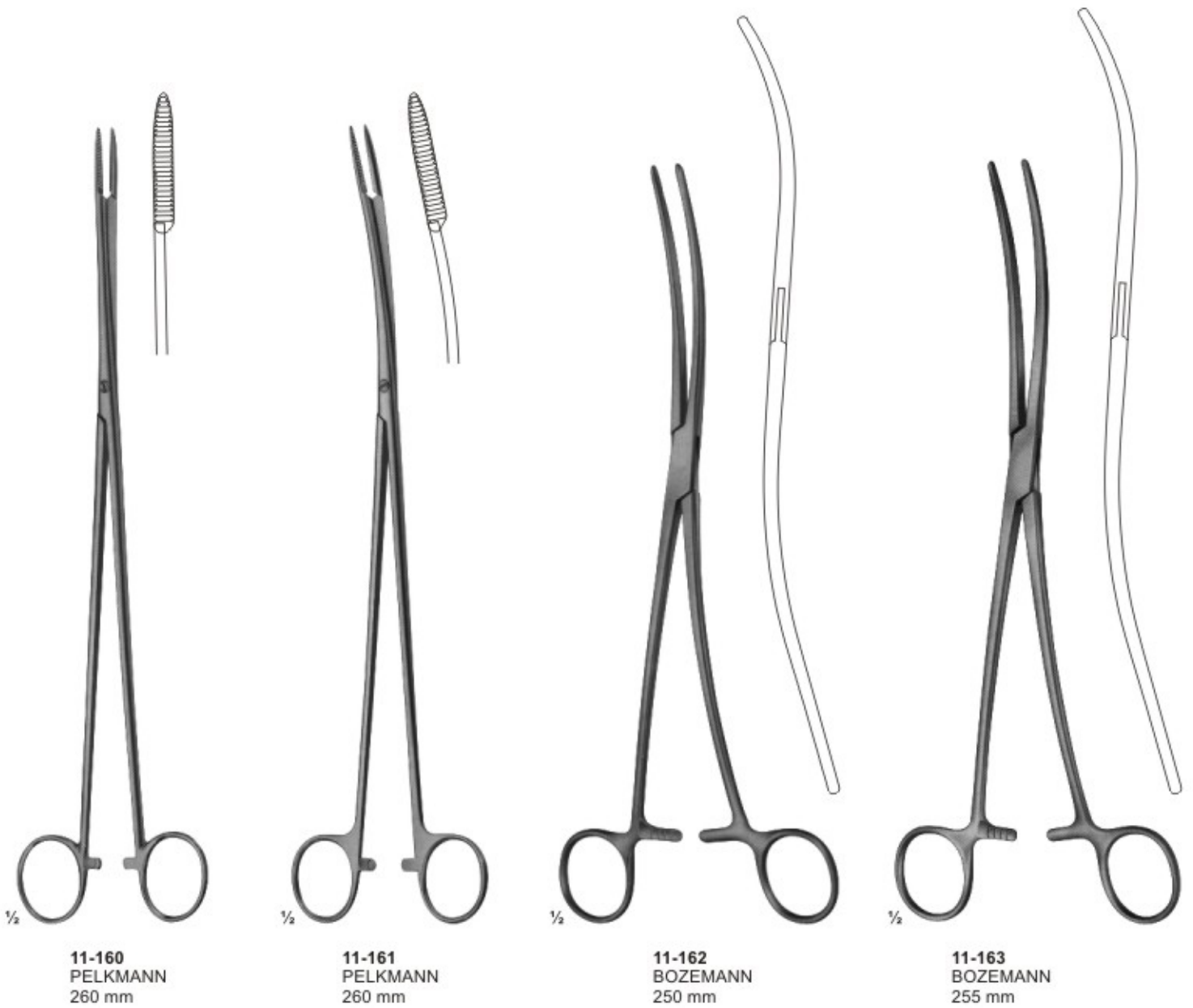

Jaws with longitudinal groove

**Polypus-and Ovum Forceps
Polypen- und Ovarienzangen**

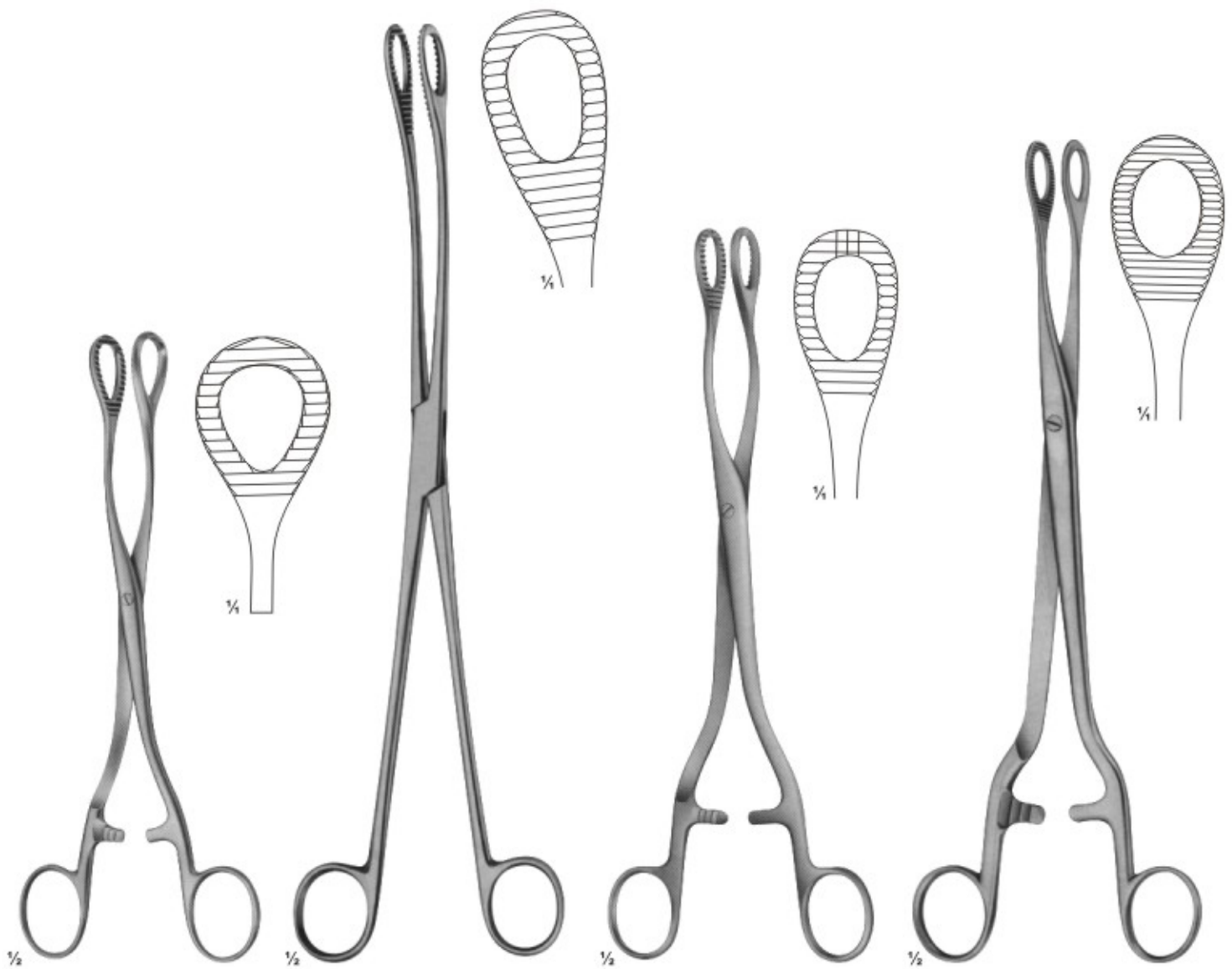

11-164
HEYWOOD-SMITH
200 mm

11-165
KELLY
320 mm

11-166
HEYWOOD-SMITH
250 mm

11-167
NOTO
280 mm

Biopsy Curettes Biopsiekuretten

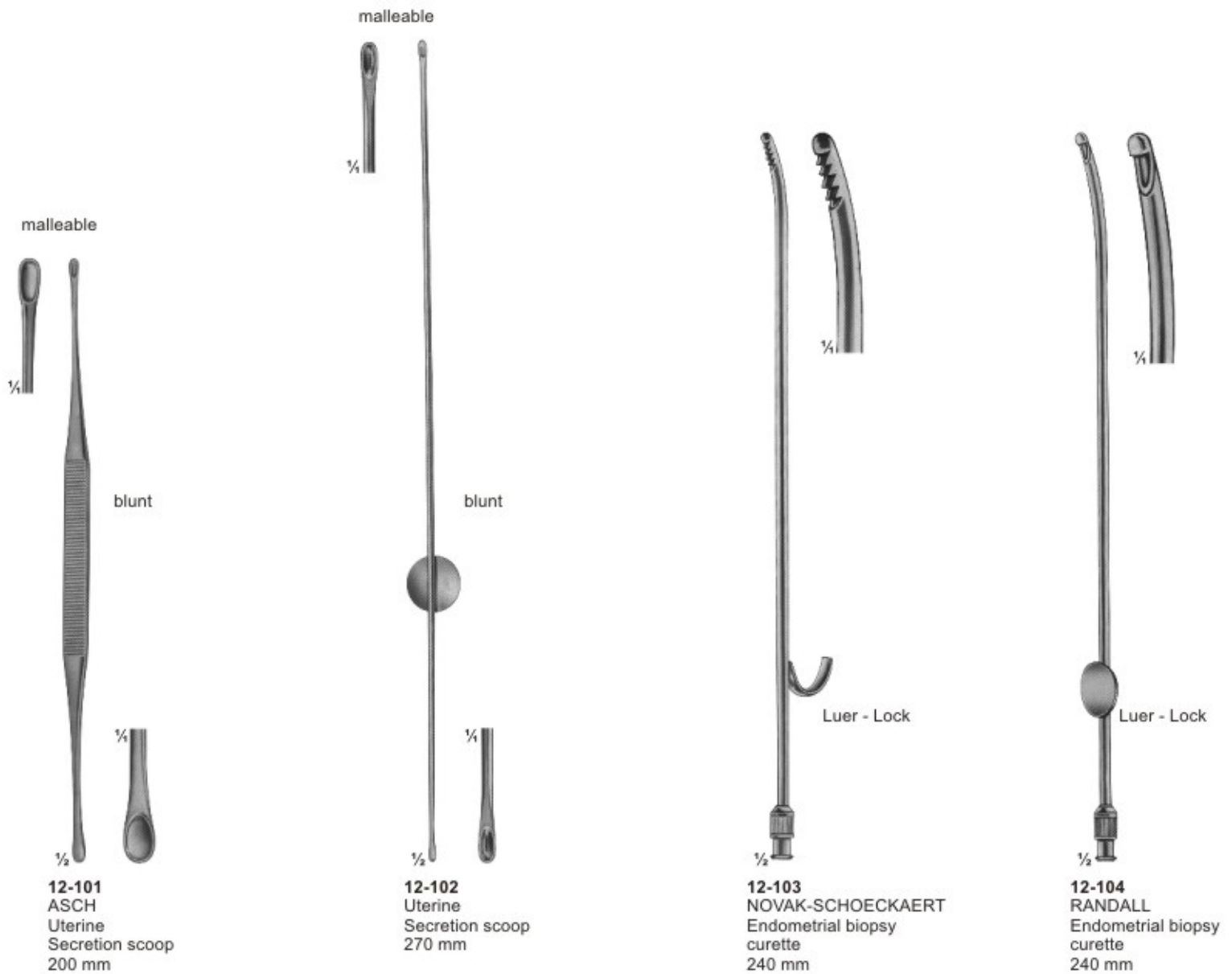

12-101
ASCH
Uterine
Secretion scoop
200 mm

12-102
Uterine
Secretion scoop
270 mm

12-103
NOVAK-SCHOECKAERT
Endometrial biopsy
curette
240 mm

12-104
RANDALL
Endometrial biopsy
curette
240 mm

Biopsy Forceps Biopsiezangen

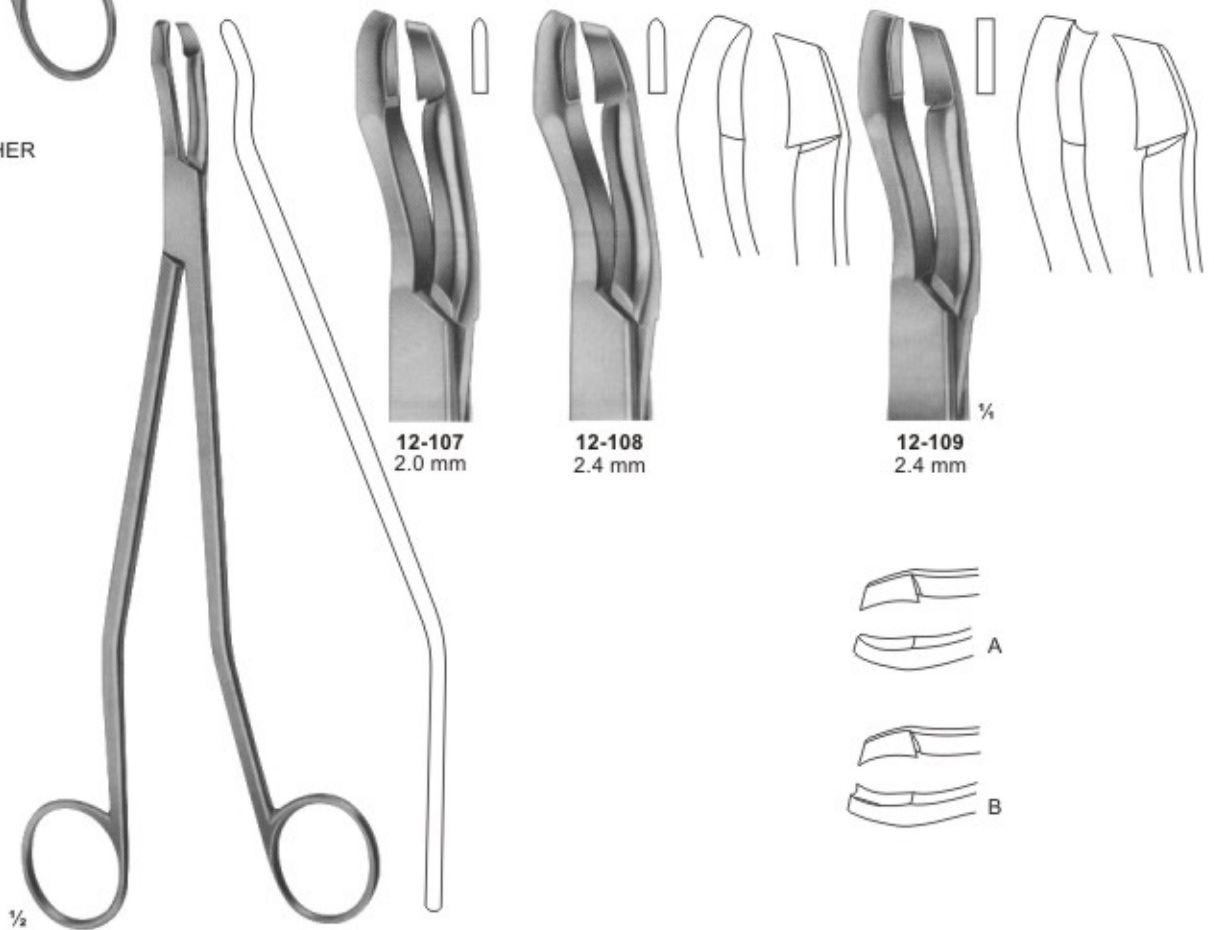
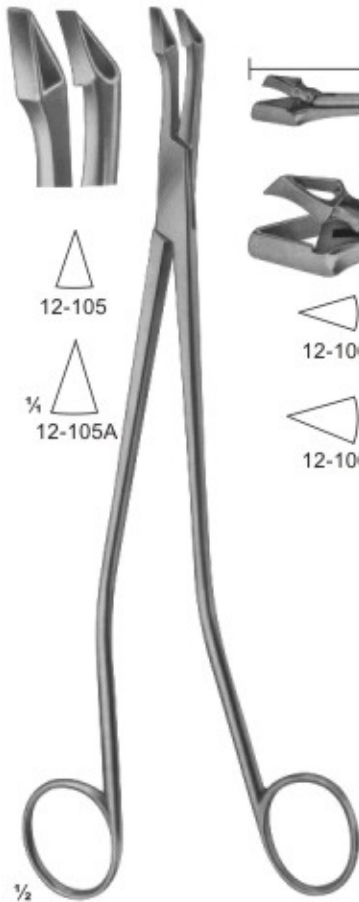
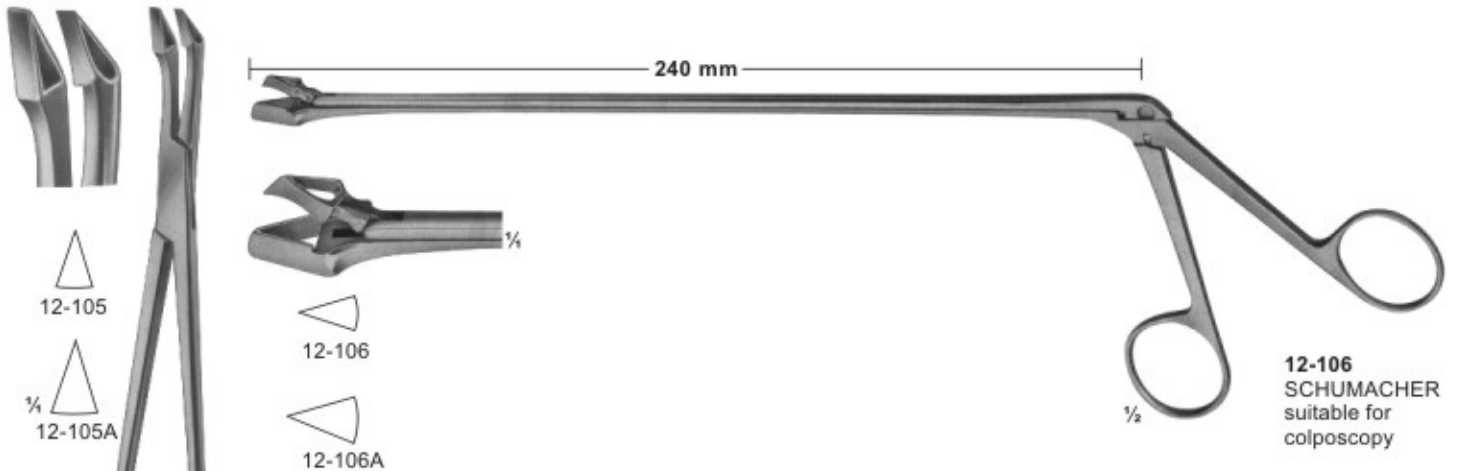

12-107 - 109
SEIDL DBP
Biopsy forceps, bayonet shaped
for portio, vagina and vulva
240mm

Biopsy Forceps Biopsiezangen

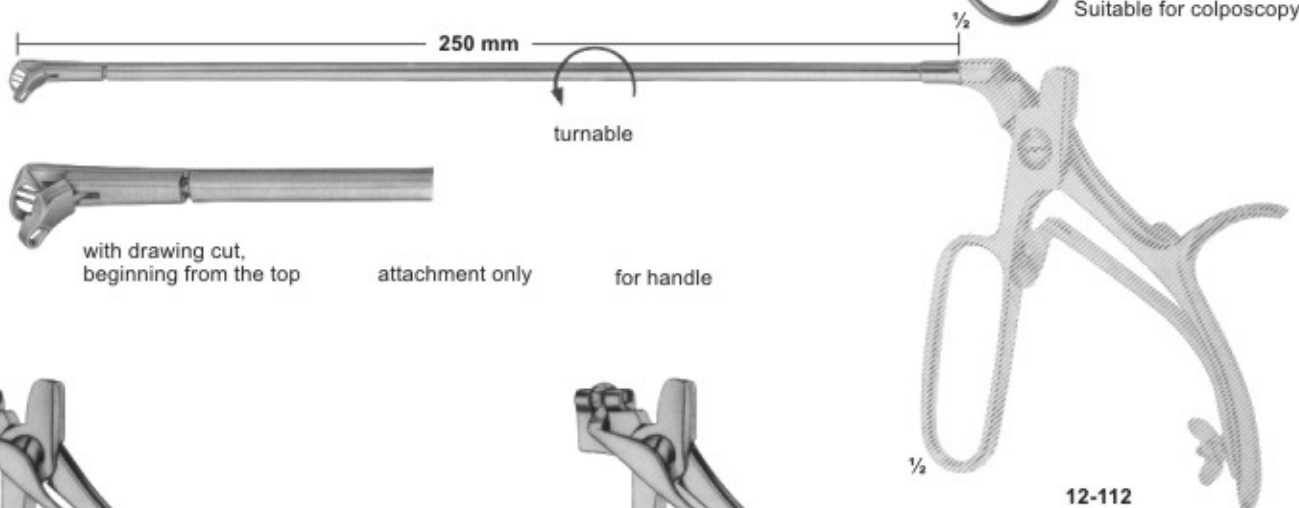
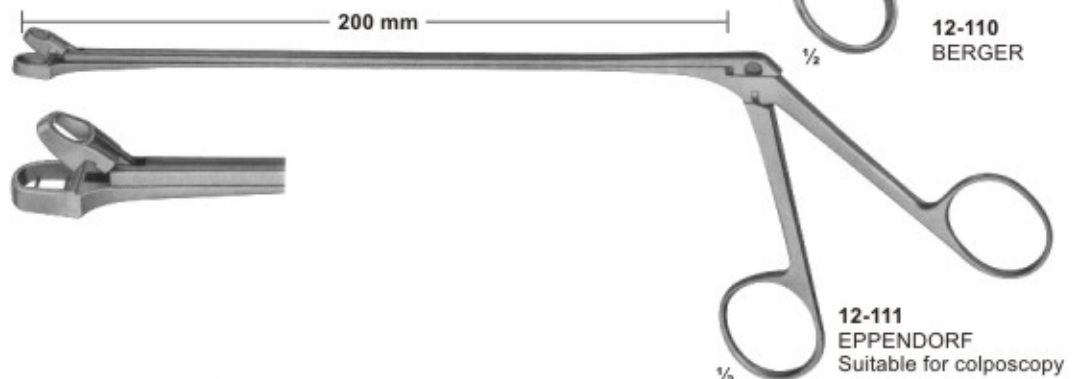
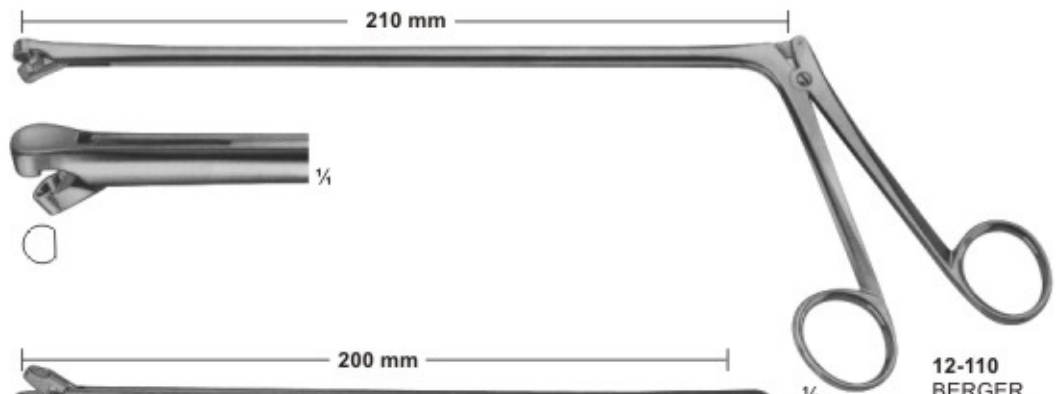

with drawing cut,
beginning from the top

attachment only

for handle

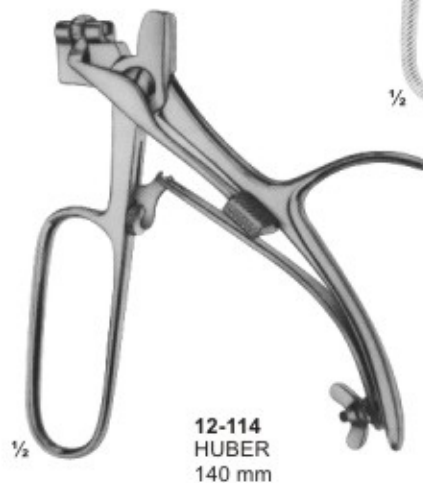

12-117 KRAUSE (Biopsy tip)



12-118 SCHEINMANN (Biopsy tip)



12-119 SCHUMACHER (Biopsy tip)
with drawing cut

Uterine Scoops Uterusloffel

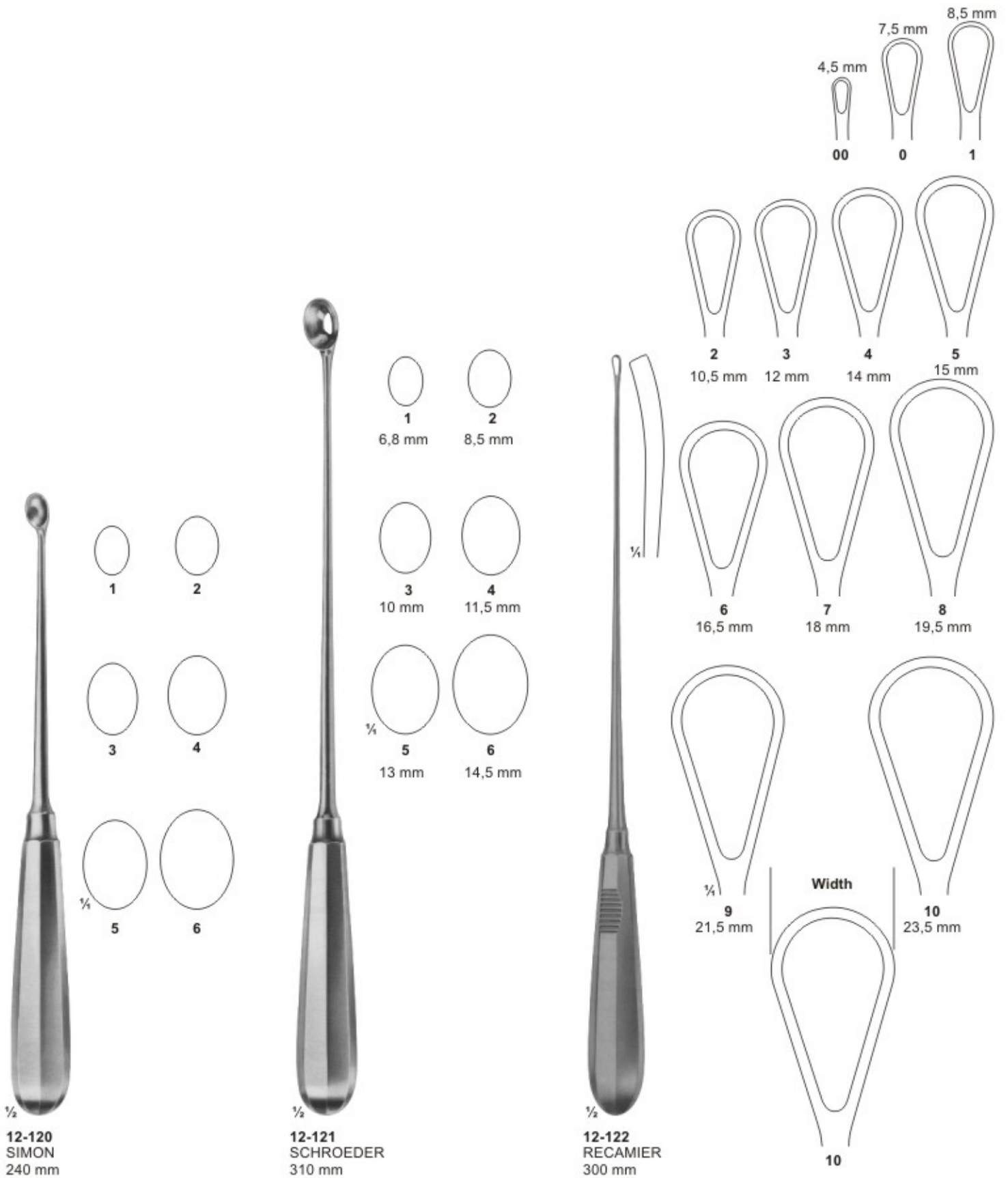



13-101
NAEGELE
355 mm



13-102
NAEGELE
400 mm



13-103
SIMPSON-BRAUN
305mm

Obstetrics- Placenta and Ovum Forceps
Geburtshilfe- Plazenttar- und Abortuszangen

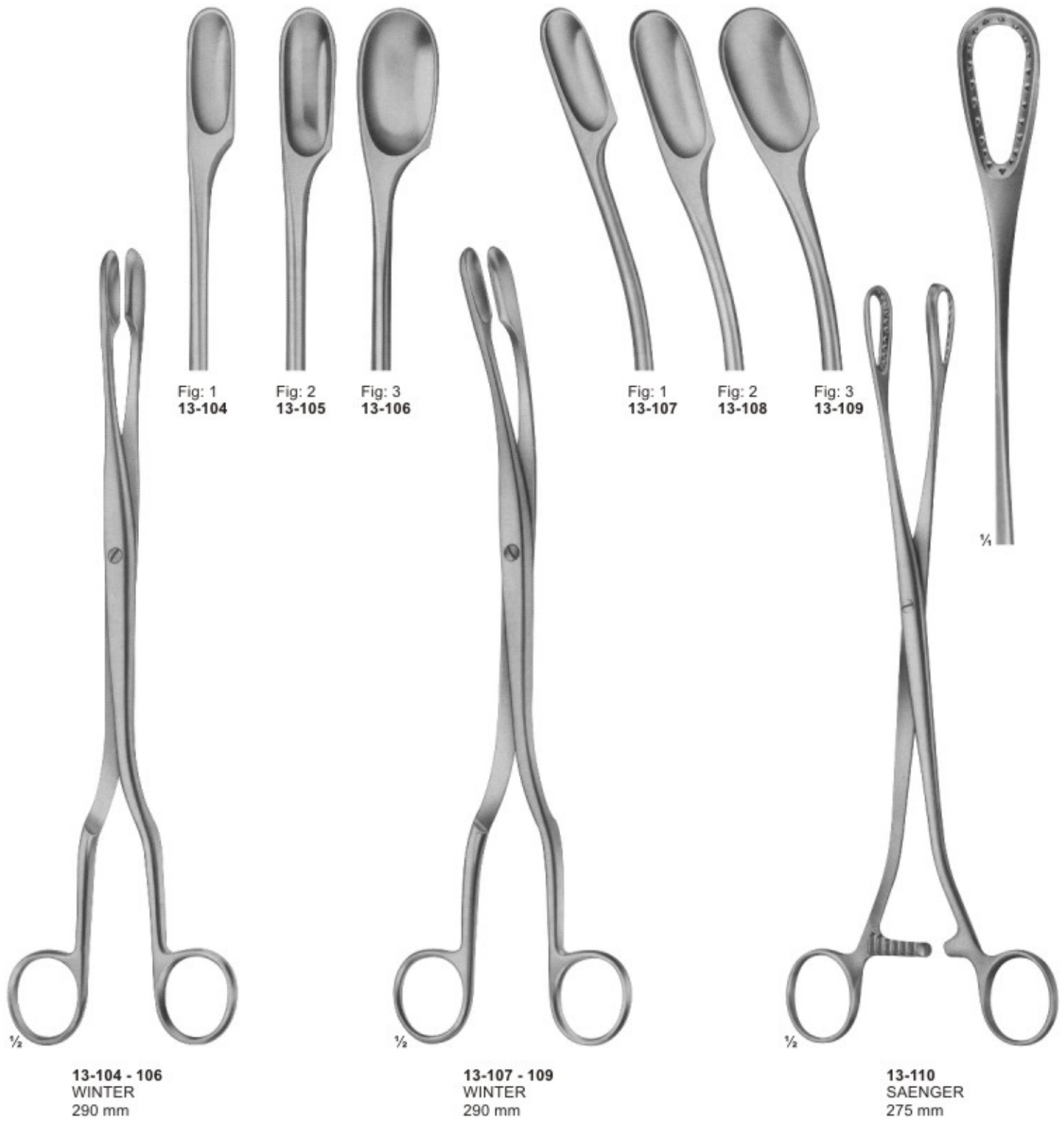

Tound-and Tracheal Hooks and Dilators

Tund-, Trachealhakchen, dilatatoren



13-111
BOSE
165 mm

13-112
BOSE
165 mm



13-113 - 115
180 mm

13-113
sharp



13-114
blunt



13-115
stumpf/blunt



13-116
FINSEN
50 mm



13-117
FINSEN
70 mm



13-118
Trousseau
120 mm



13-119
LABORDE
125 mm



13-120
LABORDE
strong pattern
135 mm



13-121
Cleaning Brush
for tracheal tubes
285 mm

Vascular Spatulas GefaBspatel

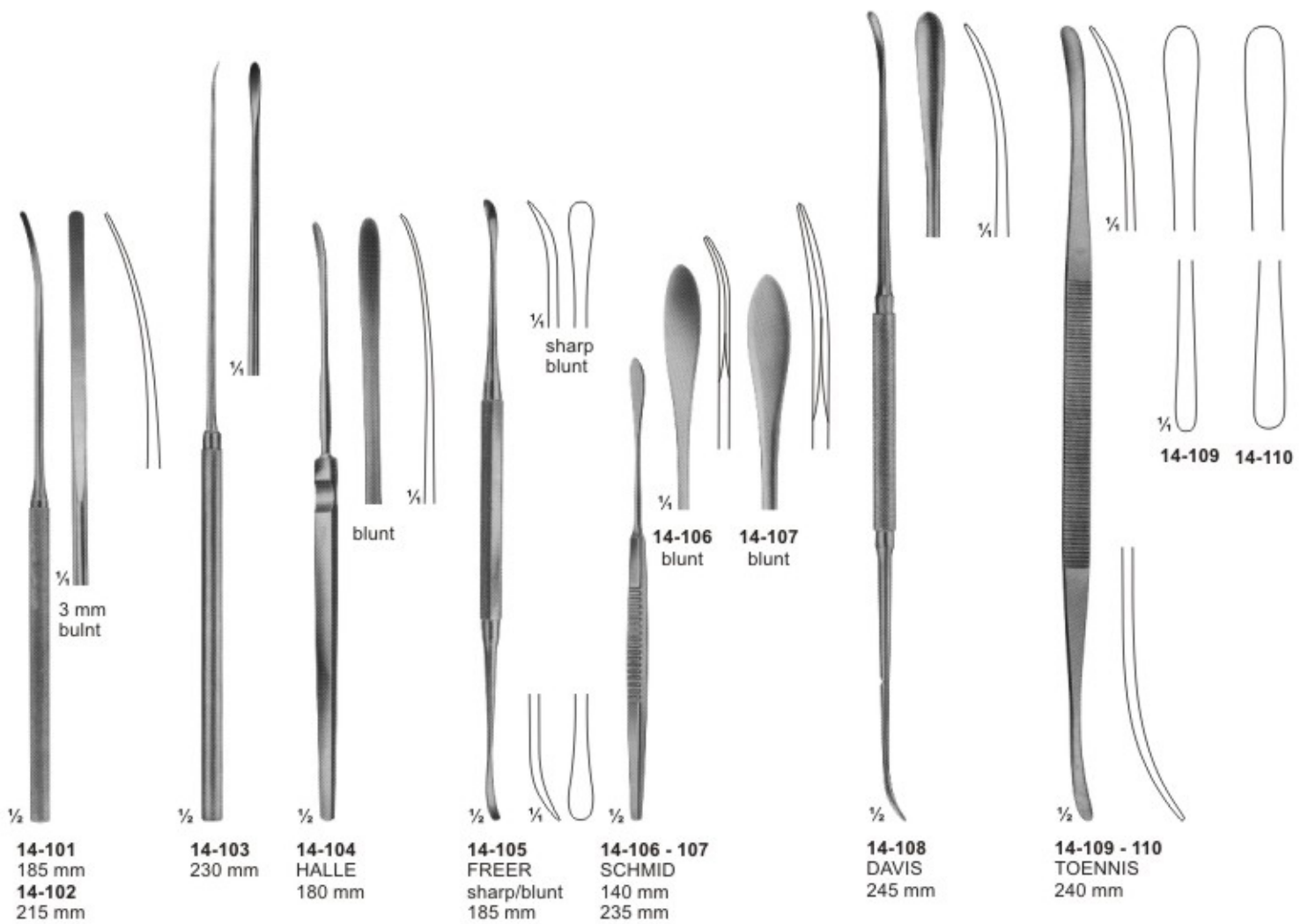

ATRAUMATA
Forceps
Pinzetten

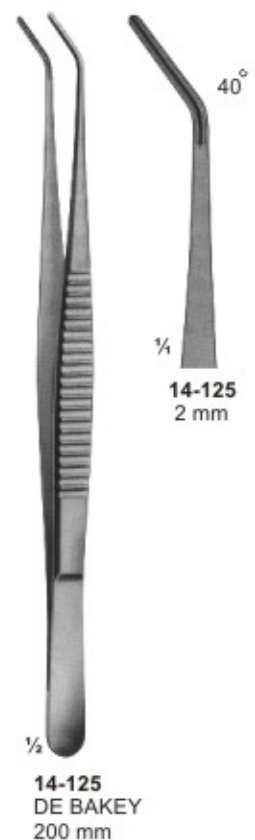
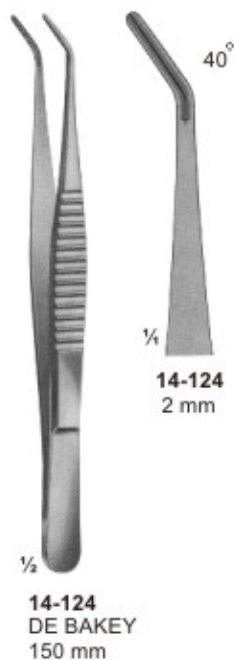
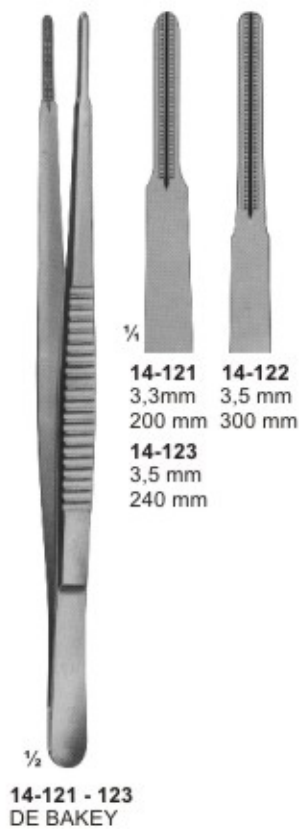
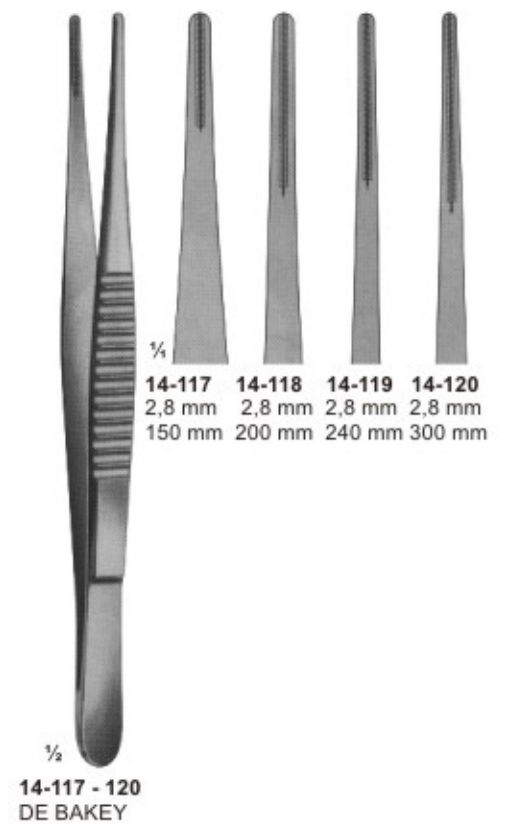
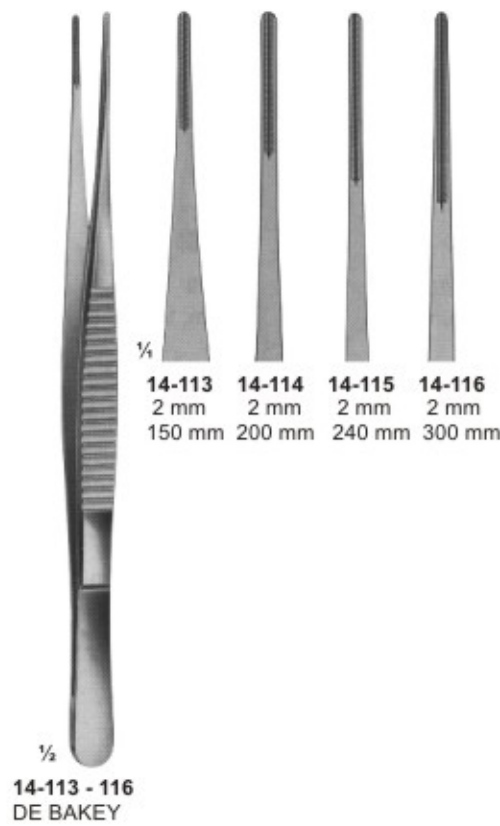
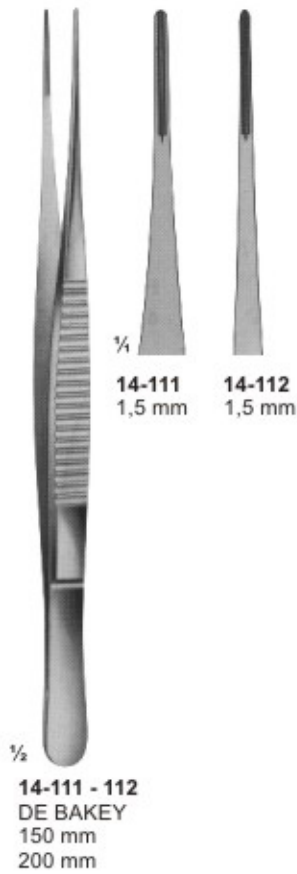

ATRAUMATA

Anastomosis- and Multi- Purpose- Clamps- Pediatric types Anastomosen- und Mehrzweckklemmen- Kinder- Modelle

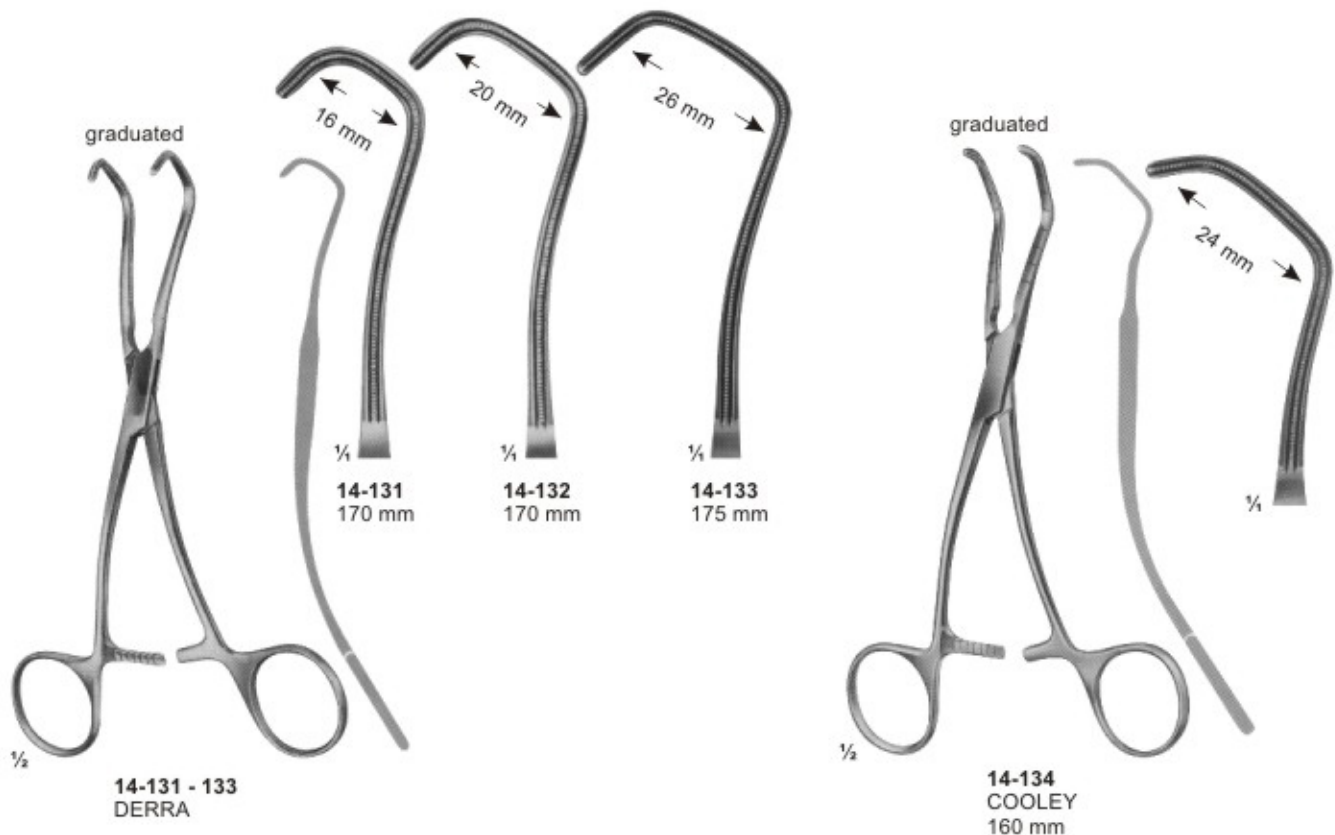
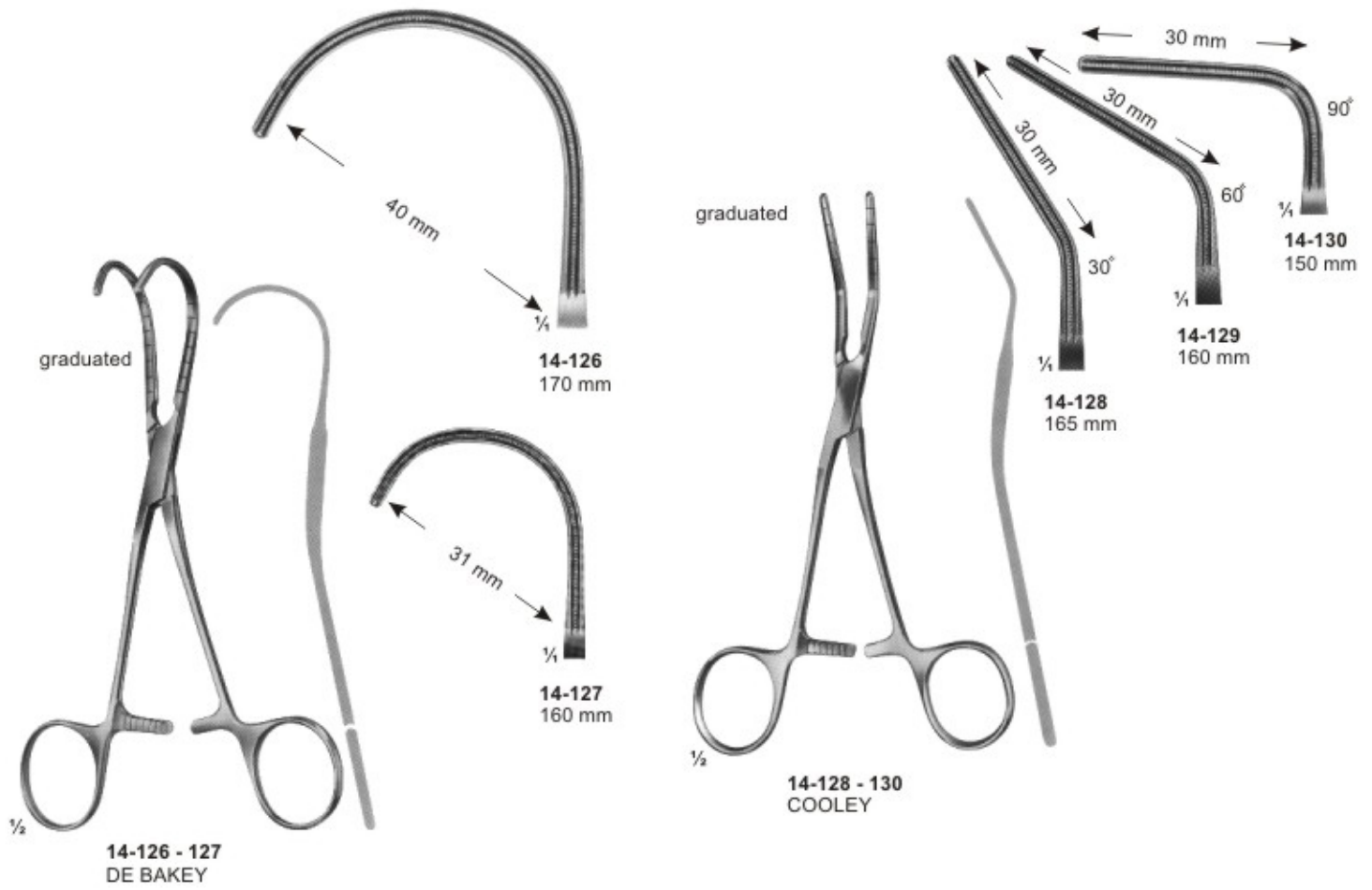

ATRAUMATA

Coarctation Clamps, Patent-Ductus & Peripheral-Vascular Clamps

Coarctationsklemmen, Patent-Ductus und
Peripheralklemmen

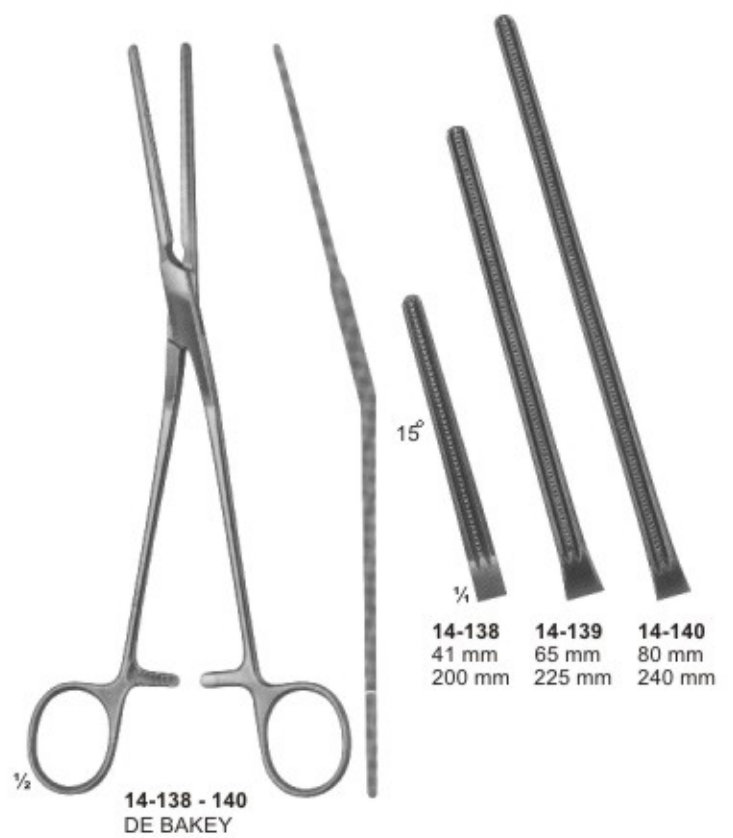

Aorta- Anastomosis Clamps Aorta- Anastomosenklemmen

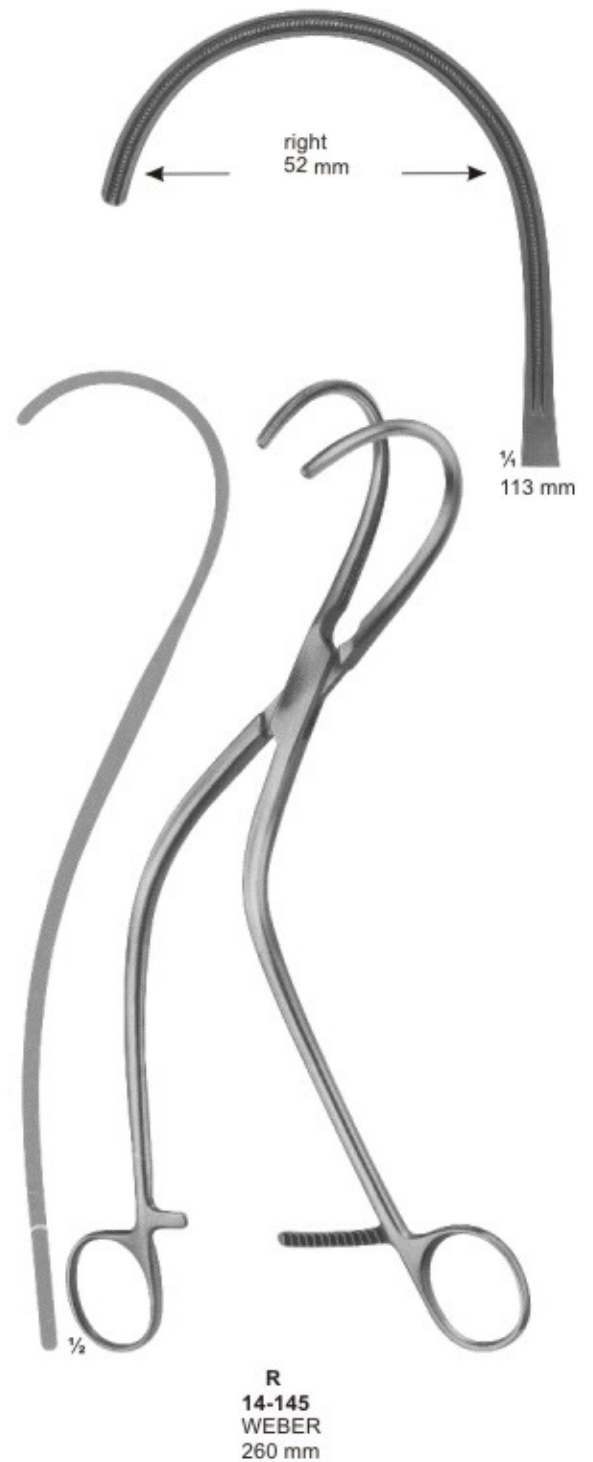
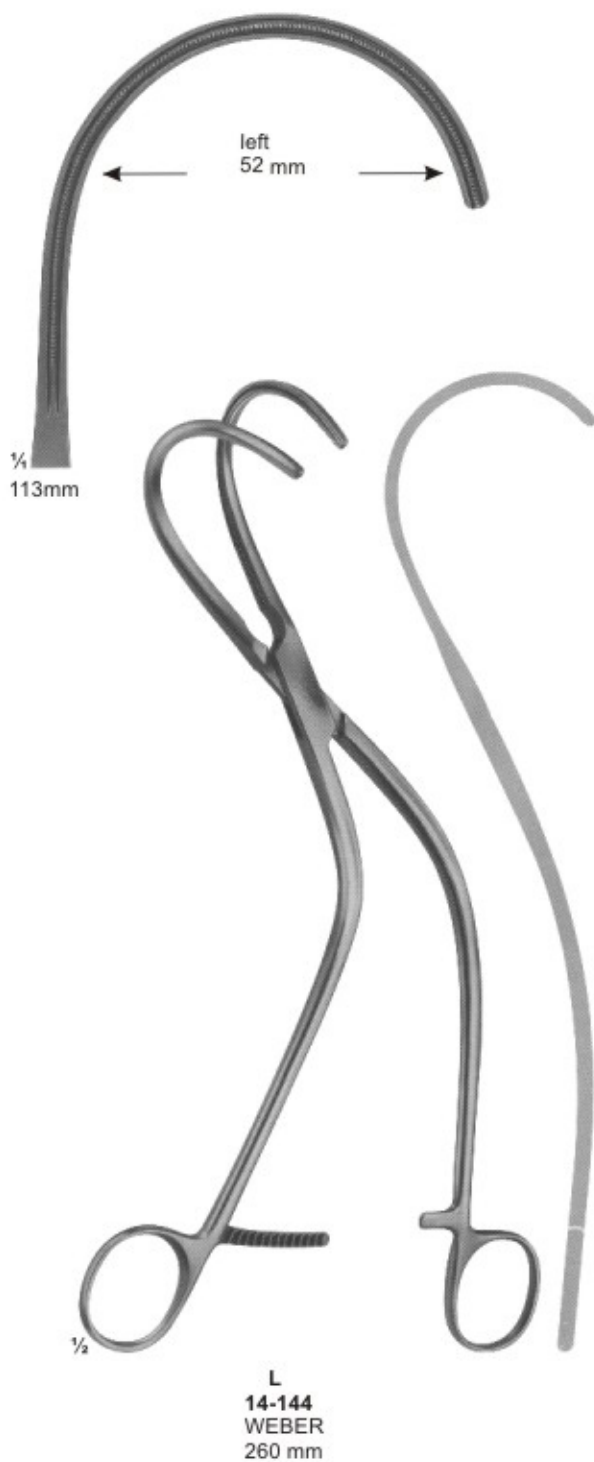

Multi- Purpose-Clamps Mehrzweckklemmen



14-146 - 149
DE BAKAY

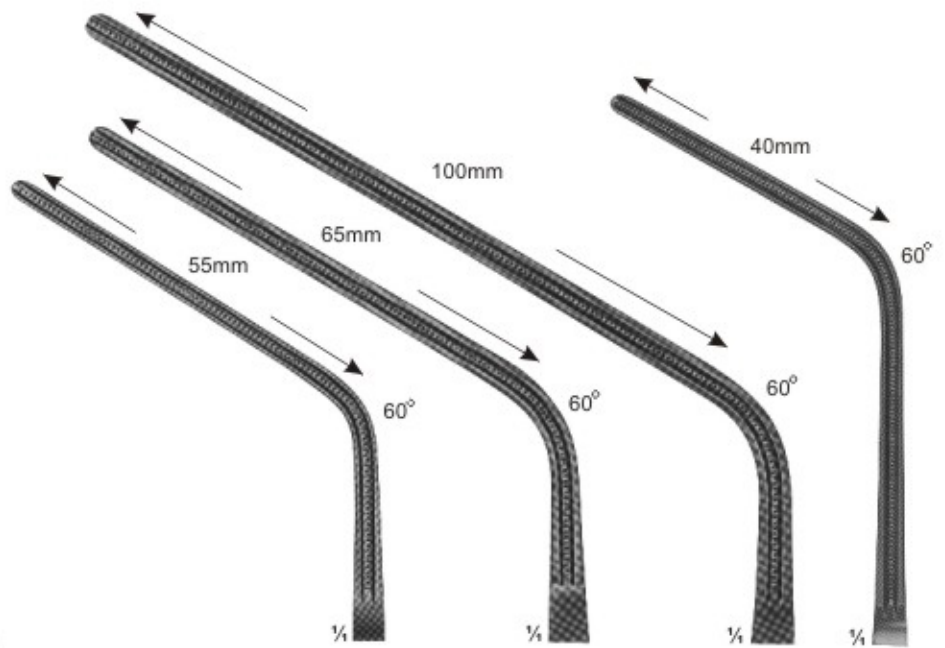

14-146 14-147 14-148 14-149

Total Length:	230 mm	280 mm	305 mm	240 mm
Length of jaws:	85 mm	100 mm	135 mm	93 mm



14-150 - 153
DE BAKAY

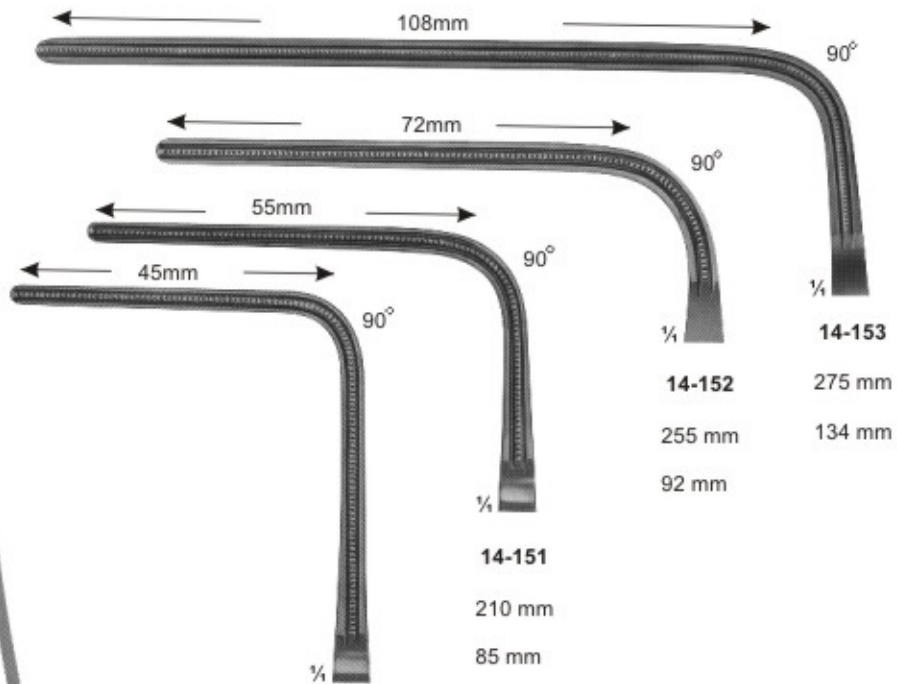

14-150

14-153

14-152

14-151

Total Length:	225 mm
Length of jaws:	93 mm

255 mm

92 mm

210 mm

85 mm

Sternum Instruments and Rib Shears
Sternum Instrumente und Rippenscheren



14-154
SCHUMACHER
Sternum shears
210 mm



14-155
LEBSCHÉ
Sternum chisel
200 mm



14-156
230 mm



14-157
COLLIN
195 mm



14-158
GLUCK
190 mm



14-159
BETHUNE
340 mm



14-160
BRUNNER
Universal pattern
340 mm



14-161
GIERTZ-STILLÉ
250 mm

Rib Spreaders Rippensperrer

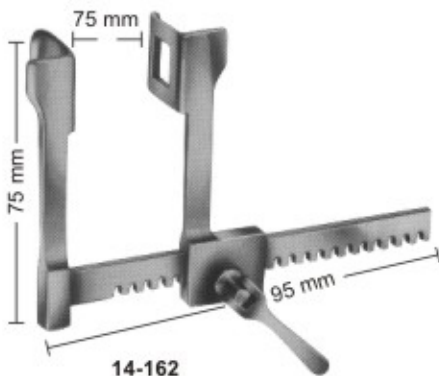

14-162
FINOCHIETTO
Blades
18X21 mm

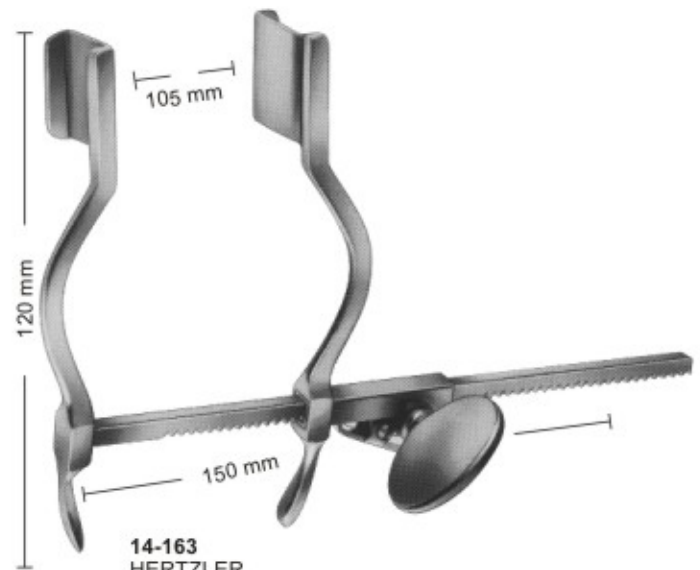

14-163
HERTZLER
Blades
20X25 mm

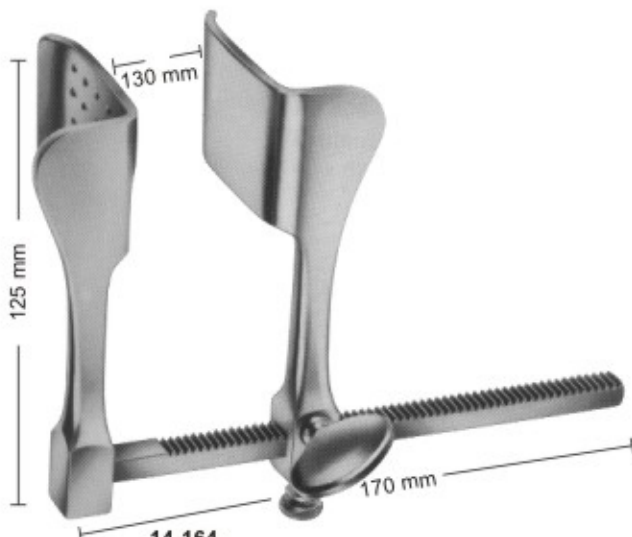

14-164
TUFFIER
Blades
43X53 mm

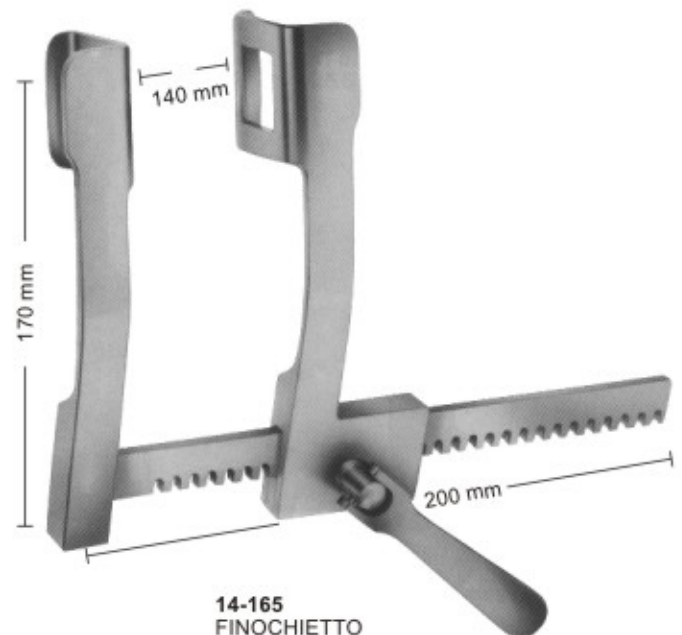

14-165
FINOCHIETTO
Blades
36X45 mm

Rib Spreaders-and Contractors Rippensperrer und - Kontraktoren



½

14-166
SELLORS
Rib spreader-and contractor
with swivel blades
200 mm



½

14-167
BAILEY
150 mm



14-168
for children

14-169
for adults

½

14-168 - 169
BAILEY
200 mm

130° upwards cutting

15-101
1 mm



KERRISON - JACOBY

FERRIS-SMITH-KERRISON

15-102
2 mm



15-103
3 mm



15-104
4 mm



15-105
5 mm

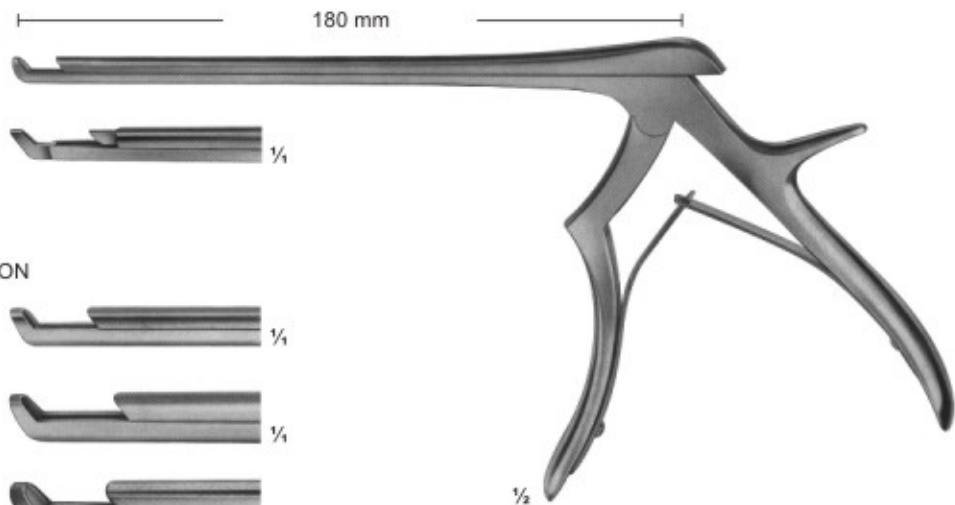

15-101 - 105

90° upwards cutting

KERRISON - JACOBY

15-106
1 mm



15-107
2 mm



FERRIS-SMITH-KERRISON

15-108
3 mm



15-109
4 mm



15-110
5 mm

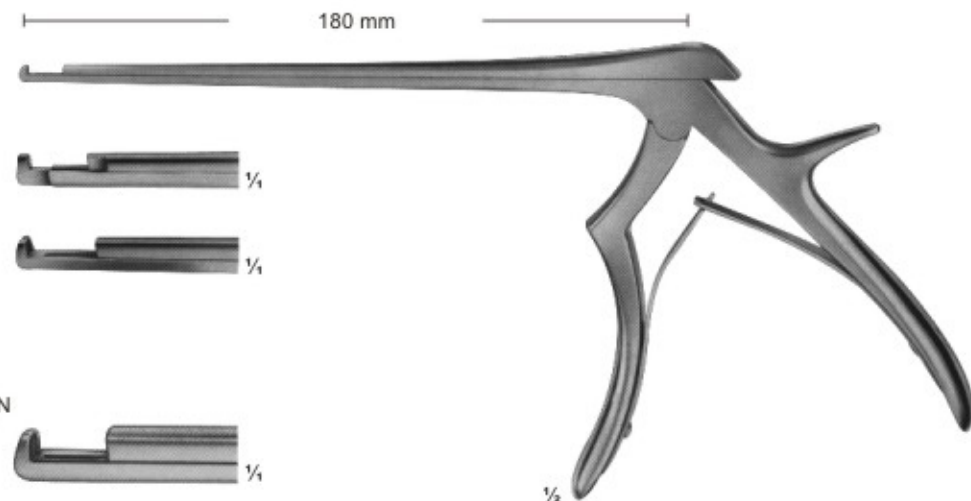

15-106 - 110

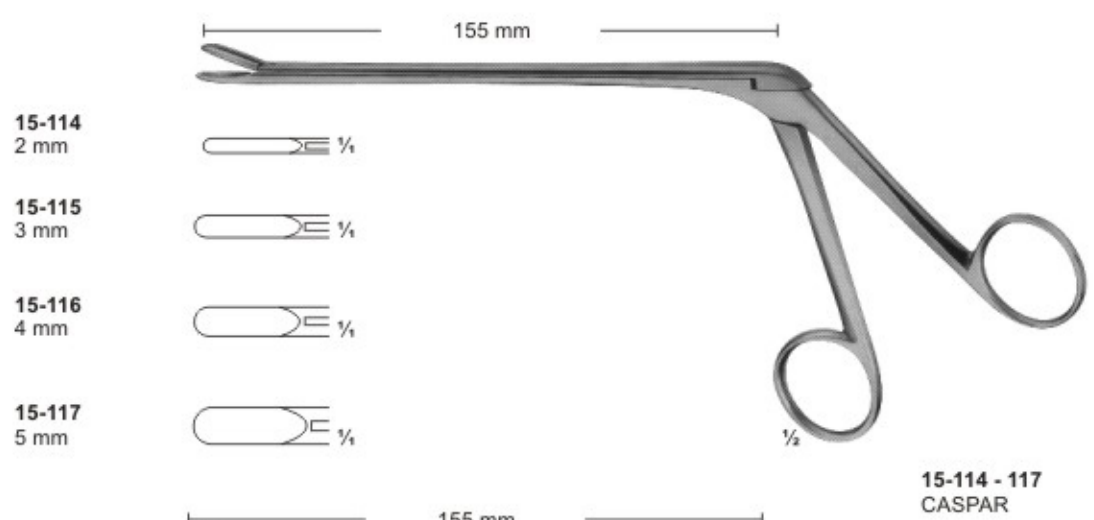
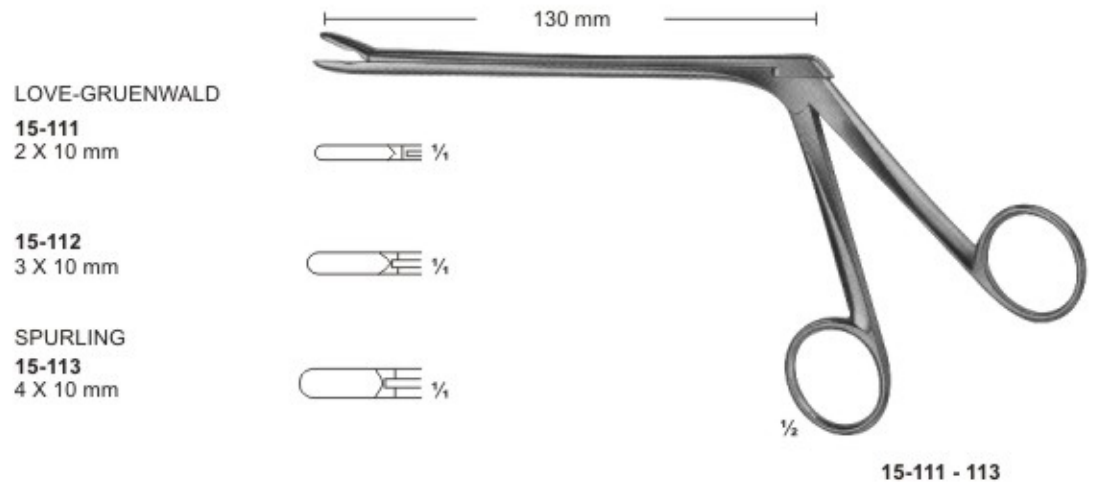

150°

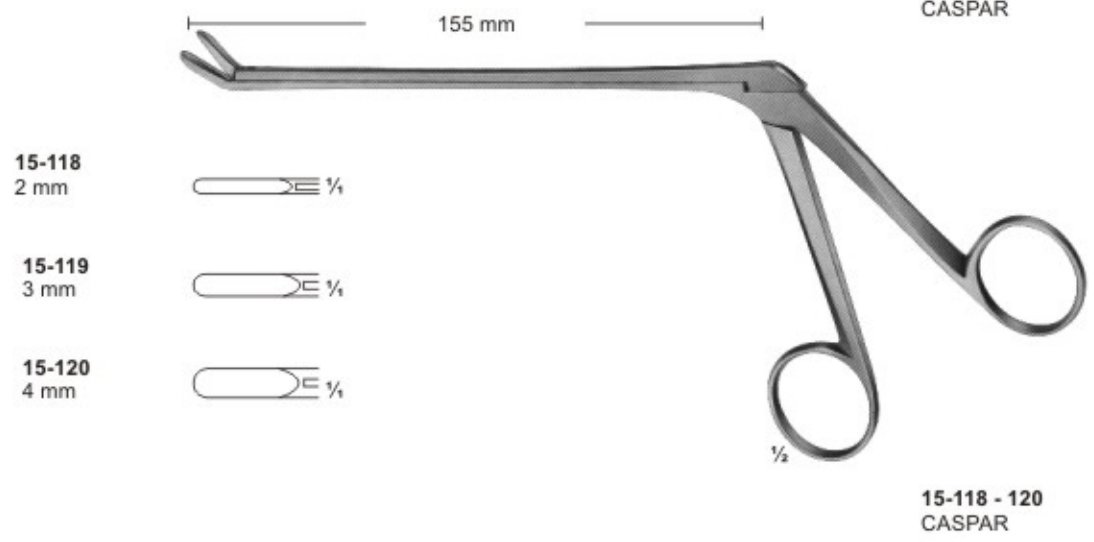

Elevators and Bone Levers

Elevatoren und Knochenheber

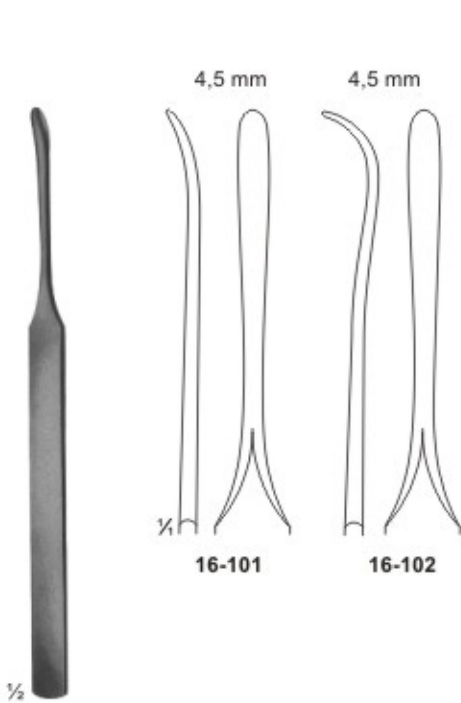

16-101 - 102
KONIG
155 mm



16-103
WILLIGER
165 mm

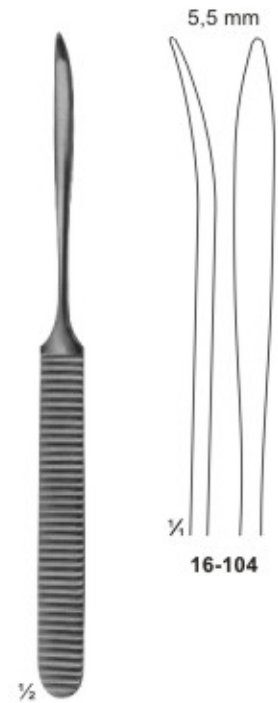

16-104
WILLIGER
170 mm

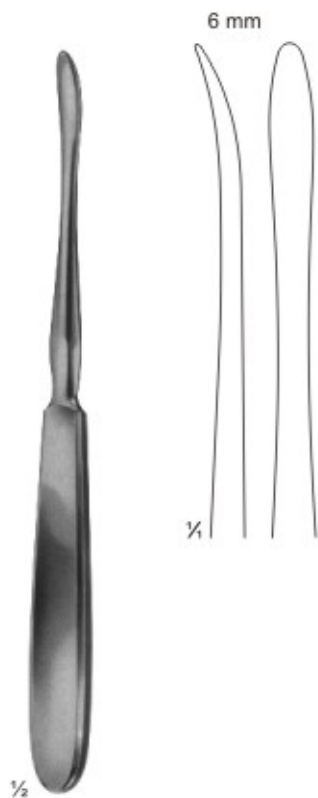

16-105
QUERVAIN
195 mm

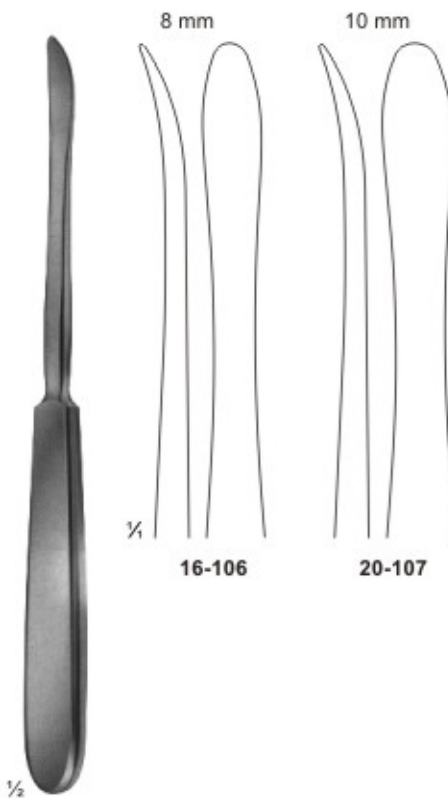

16-106 - 107
LANGENBACK
195 mm

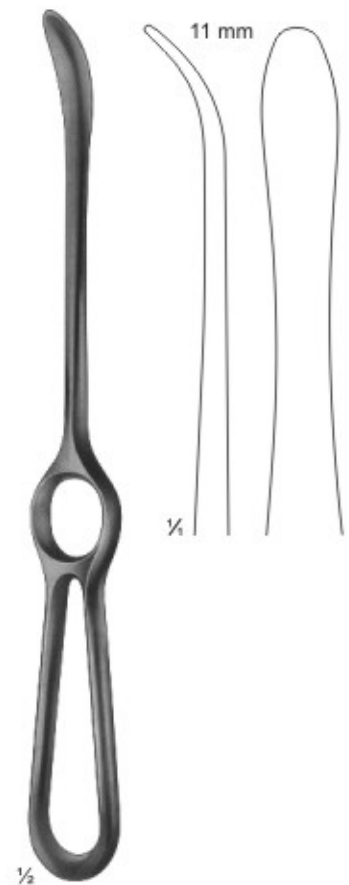

16-108
LANGENBACK
230mm

Bone Levers
Knochenheber



16-109
LANE TRETHOWAN
215mm

16-110
LANE
255mm

16-111
LANGE-HOHMANN
250mm

16-112 - 113
LANGE-HOHMANN modif.
16-112 265mm
16-113 280mm

16-112
30 mm
16-113
33 mm



16-117 - 118
PARTSCH
150 mm

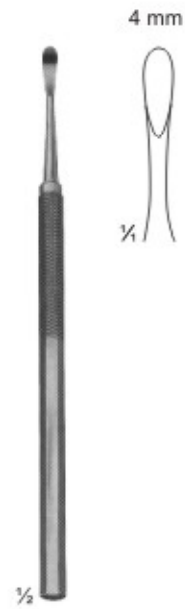

16-119
PARTSCH mod. LANGE
145 mm



16-120
MC KENTY
155 mm

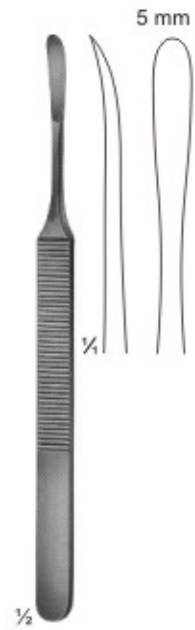

16-121
KOENIG
155 mm

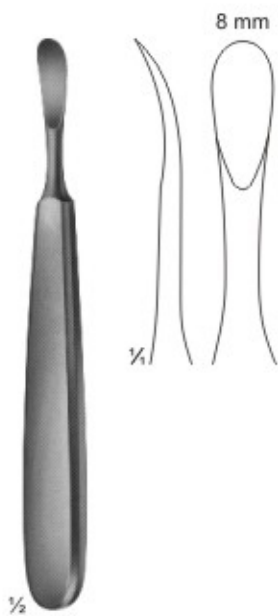

16-122
TRELAT
150 mm

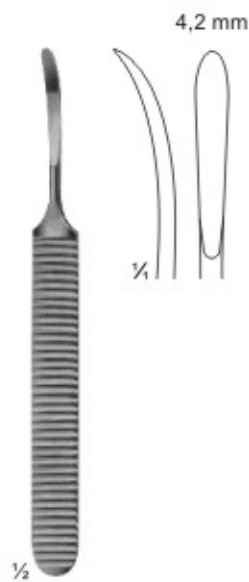

16-123
WILLIGER
140 mm

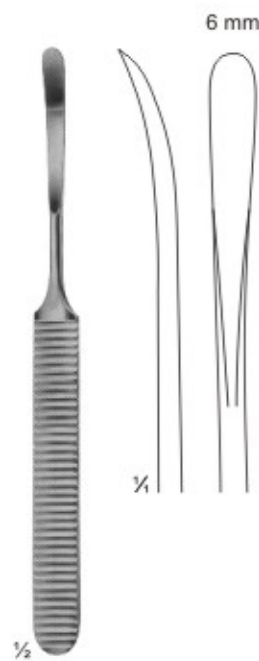

16-124
WILLIGER
160 mm

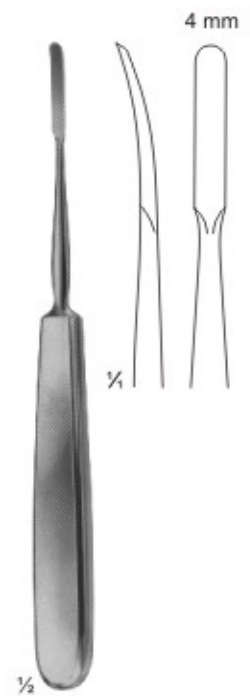

16-125
JOSEPH
170 mm

Bone File and Rasps Knochen-Feilen und - Raspein

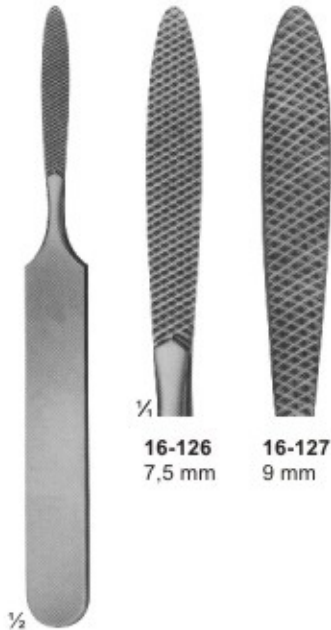

16-126
JOSEPH
fine, chequered

16-127
coarse, chequered
165 mm

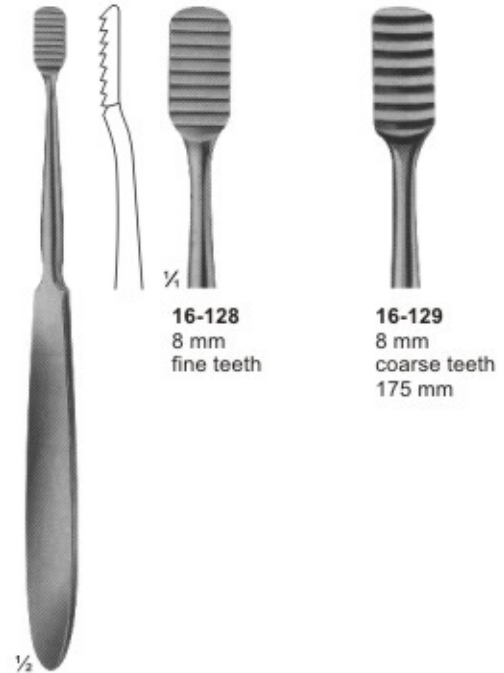

16-128 - 129
LEWIS



16-130
MALTZ
down stroke
180 mm

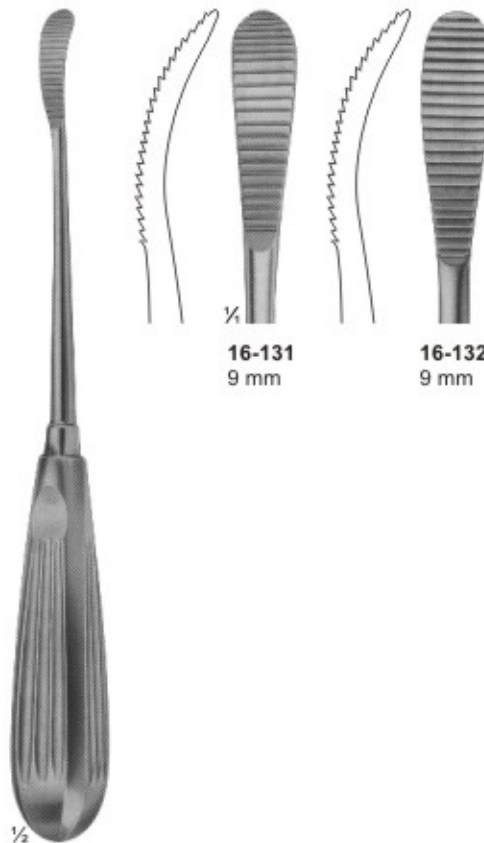

16-131 - 132
AUFRICHT
up stroke
16-132
down stroke
220 mm



16-133
GALLAHER
190 mm

Bone Currettes Scharfe Loffel



16-134
JACOBSON
140 mm



16-135
MARTINI
140 mm



16-137
MARTINI
140 mm



16-138
WILLIGER
145 mm



16-139
JANSEN
160 mm



16-140
BARTH
180 mm



16-141
VOLKMANN
130 mm

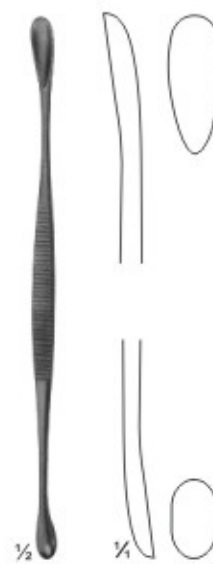

16-142
VOLKMANN
145 mm

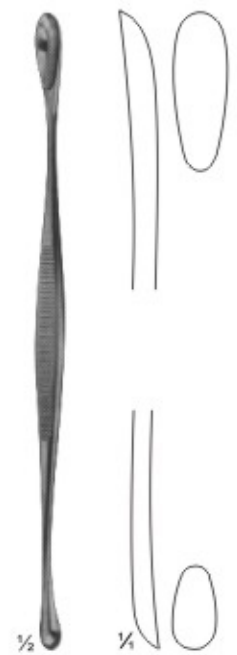

16-143
VOLKMANN
170 mm

Mallets Weights refer to the heads of the mallets
Hammer Die Gewichtsangaben beziehen sich auf
den Kopf des jeweiligen Hammers



∅ 20 mm

½

17-101
MEAD
185 g
with interchangeable
plastic disks
190 mm
17-102
pair of spare disks



∅ 25 mm

½

17-103
140 g
with interchangeable
plastic disks
185 mm
17-104
pair of spare disks



∅ 30 mm

½

17-105
COTTLE
140 g
1 Side Flat
1 Side convex
185 mm



∅ 22 mm

½

17-106
165 g
lead filled head
190 mm

Osteotomes, Chisels and Gouges

Osteotome, Flach- und Hohlmeißel



17-107
MANNERFELT
Gouge
155 mm

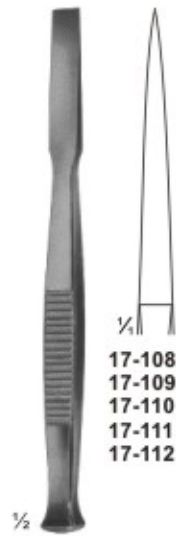

17-108 - 112
Osteotomes
140 mm

- 17-108 4 mm
- 17-109 6 mm
- 17-110 8 mm
- 17-111 10 mm
- 17-112 12 mm

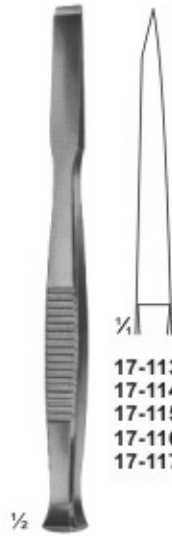

17-113 - 117
Chisels
140 mm

- 17-113 4 mm
- 17-114 6 mm
- 17-115 8 mm
- 17-116 10 mm
- 17-117 12 mm



17-118 - 122
Gouges
140 mm

- 17-118 4 mm
- 17-119 6 mm
- 17-120 8 mm
- 17-121 10 mm
- 17-122 12 mm



PARTSCH
17-123 - 126
Chisels
140 mm

- 17-123 3 mm
- 17-124 4 mm
- 17-125 5 mm
- 17-126 6 mm

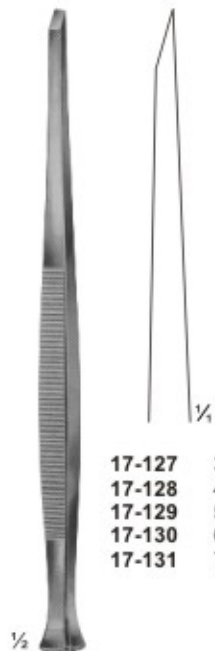

PARTSCH
17-127 - 131
Chisels
170 mm

- 17-127 3 mm
- 17-128 4 mm
- 17-129 5 mm
- 17-130 6 mm
- 17-131 7 mm

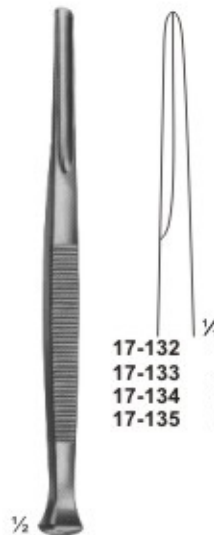

PARTSCH
17-132 - 135
Gouges
140 mm

- 17-132 3 mm
- 17-133 4 mm
- 17-134 5 mm
- 17-135 6 mm

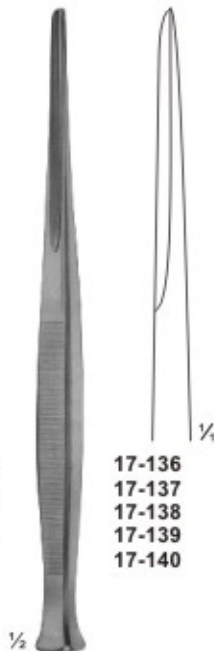

PARTSCH
17-136 - 140
Gouges
170 mm

- 17-136 3 mm
- 17-137 4 mm
- 17-138 5 mm
- 17-139 6 mm
- 17-140 7 mm



LUCAS
17-141 - 142
Chisels
160 mm

- 17-141 4 mm
- 17-142 6 mm



LUCAS
17-143 - 144
Gouges
160 mm

- 17-143 3 mm
- 17-144 5 mm

Bone Holding Forceps Knochenhaltezangen

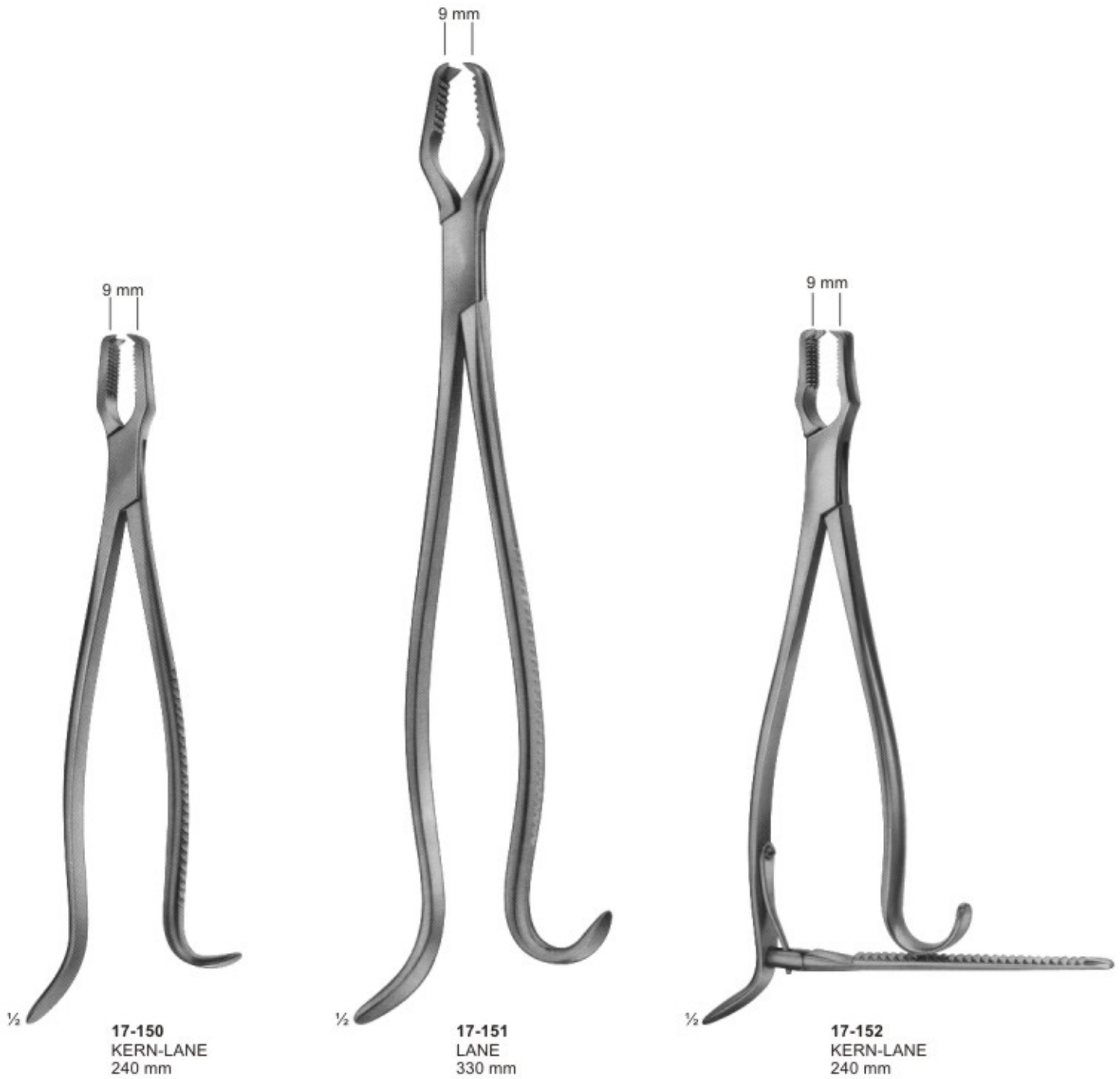

Bone Clamps Knochenhalteklammern



½
17-153 - 154
LOWMAN
17-153 170 mm
17-154 205 mm



½
17-155
LOWMAN-GERSTER
210 mm



½
17-156
LOWMAN-HOGLUND
175 mm

Bone Rongeurs Hohlmeißelzangen



17-157
LUER
150 mm

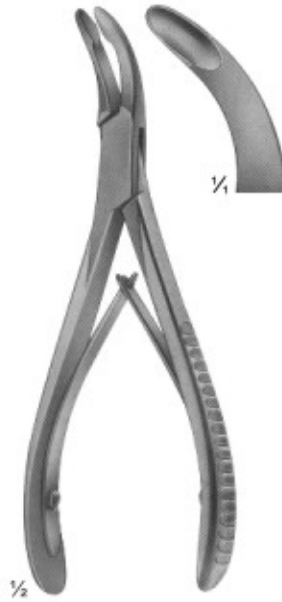

17-158
LUER
155 mm

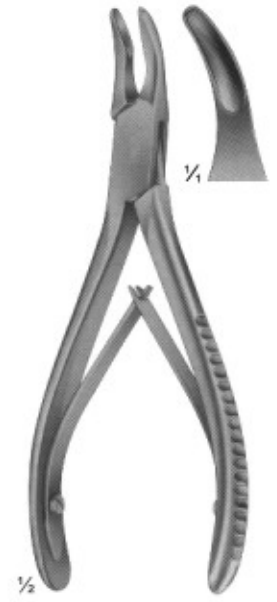

17-159
BLUMENTHAL
155 mm



17-160
BLUMENTHAL
150 mm

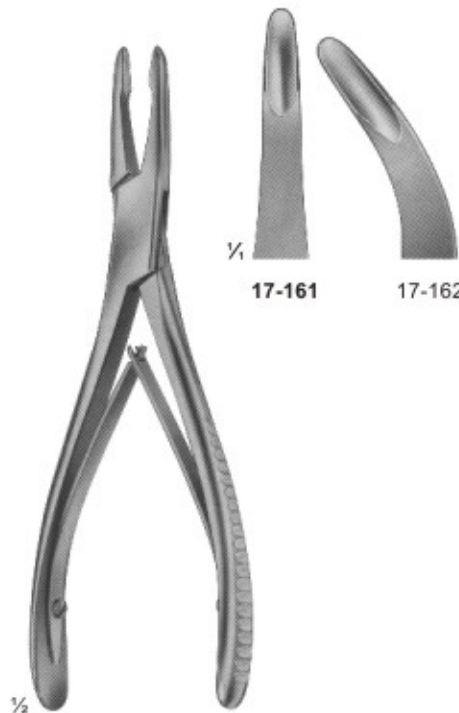

17-161 - 162
JANSEN
175 mm

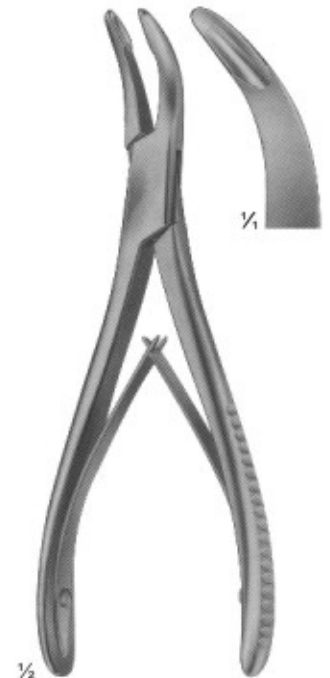

17-163
BANE-HARTMANN
175 mm

Bone Rongeurs HohlmeiBelzangen



17-164
STILLE
235 mm



17-165
LEKSELL-STILLE
240mm

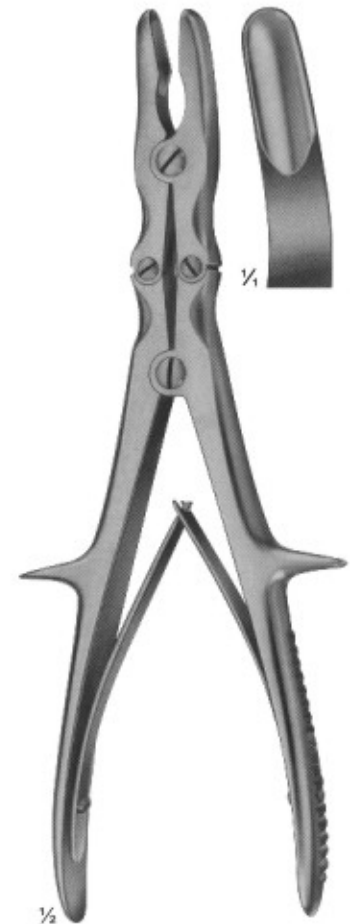

17-166
STILLE-RUSKIN
240mm

Bone Cutting Forceps Knochensplitterzangen

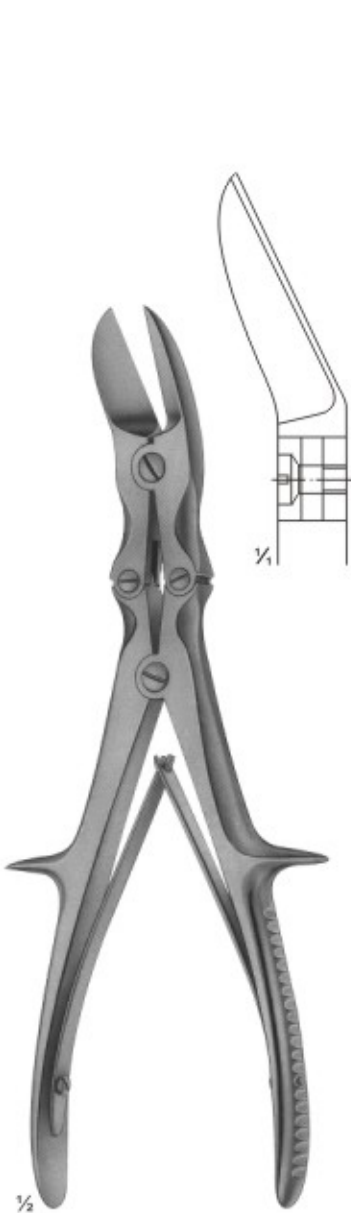

17-167
LISTON
curved on flat
240 mm

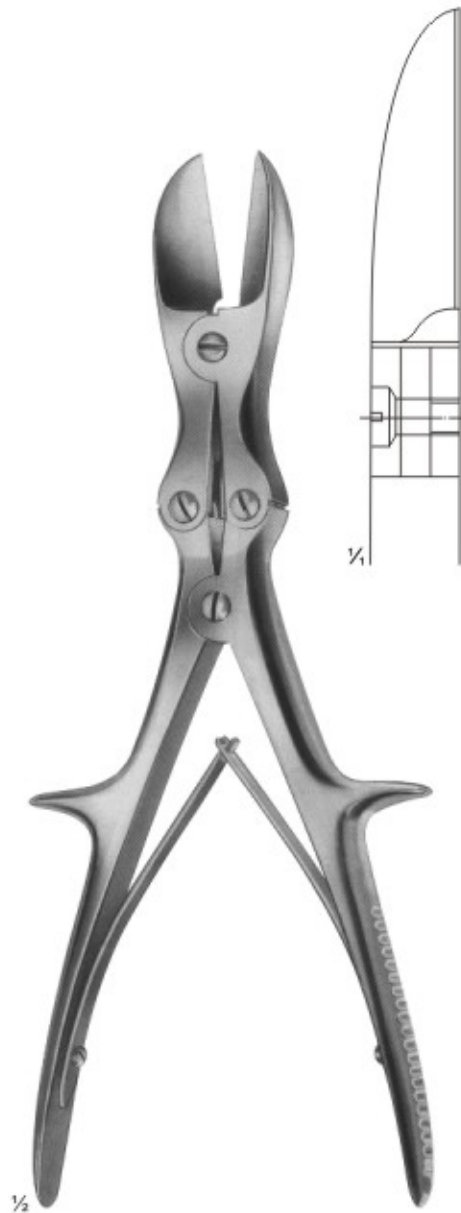

17-168
LISTON
straight
280 mm

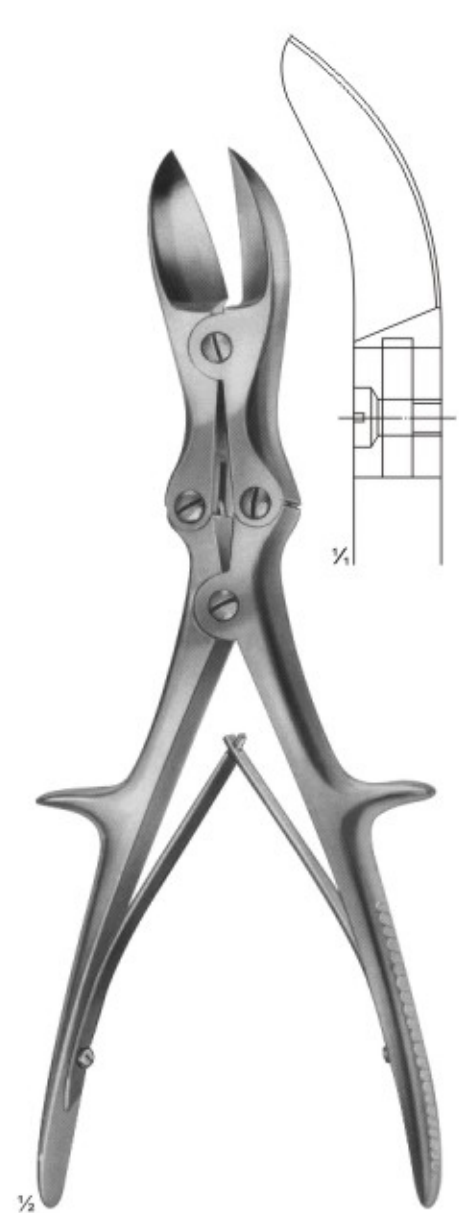

17-169
LISTON
curved on flat
280 mm

Plaster Shears Gipsscheren



17-170
STILLE-AESCULAP
260 mm



17-171
STILLE-AESCULAP
360 mm

Plaster Spreader, Plaster Breakers Gipsspreizer, Gipsabreißzangen



17-172
HENING
270 mm



17-173
MOD.USA
230 mm



17-174
290 mm



with removable jaws



17-175 - 176
WOLFF
17-175 180 mm
17-176 240 mm
plaster breakers

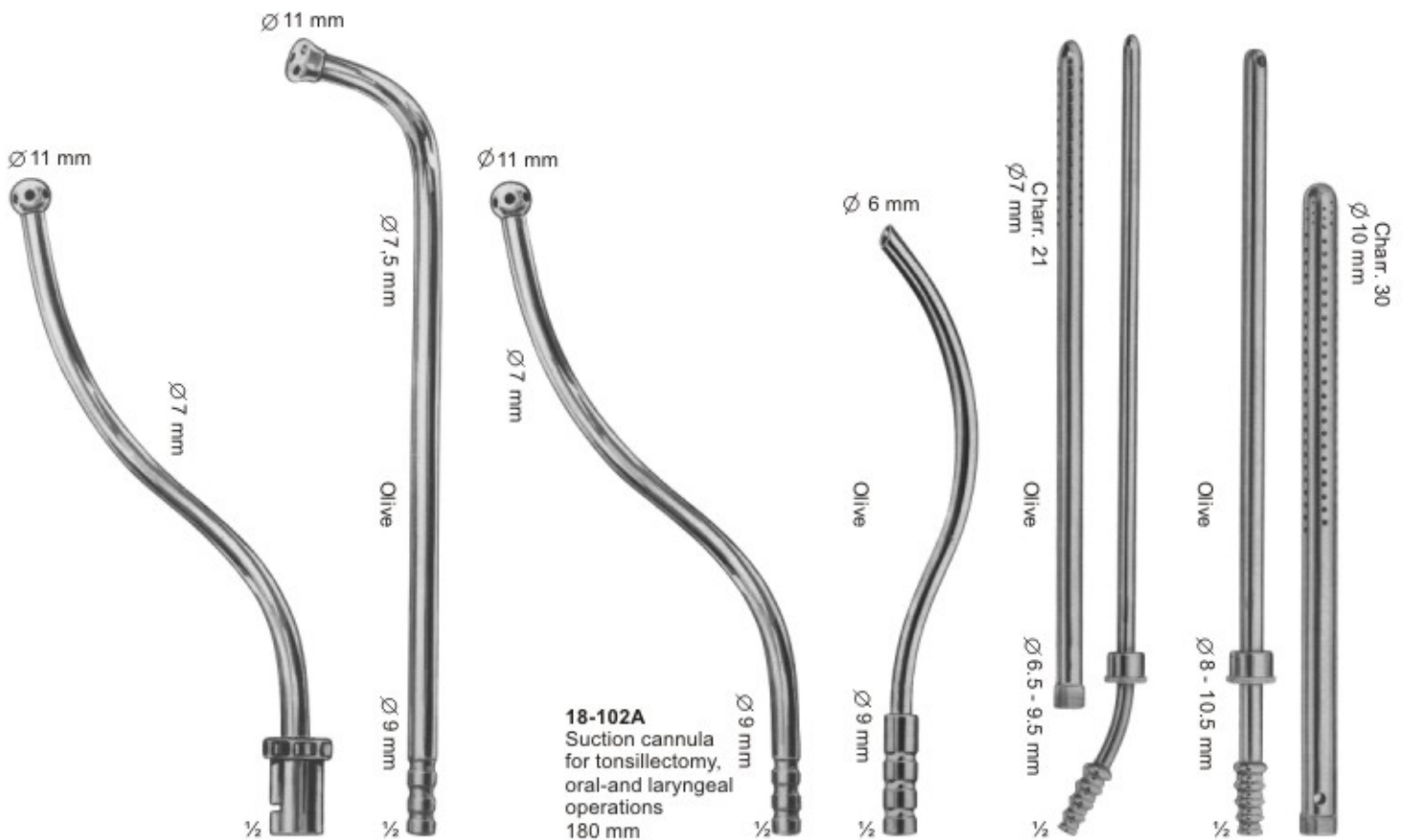

18-101
For tonsillectomy,
oral-and laryngeal
operations
180 mm

18-102
Suction cannula
for tonsillectomy,
oral-and laryngeal
operations
220 mm

18-102A
Suction cannula
for tonsillectomy,
oral-and laryngeal
operations
180 mm

18-103
S-shaped blunt cannula
for aspirating fluid from
the excretory ducts of
large glands and for
keeping the operating
area clear
170 mm

18-104
POOL
Suction cannula,
with outer tube
to be screwed of
225 mm

18-105
POOL
Suction cannula,
with outer tube
to be screwed off
225 mm

Suction Instruments Sauginstrumente

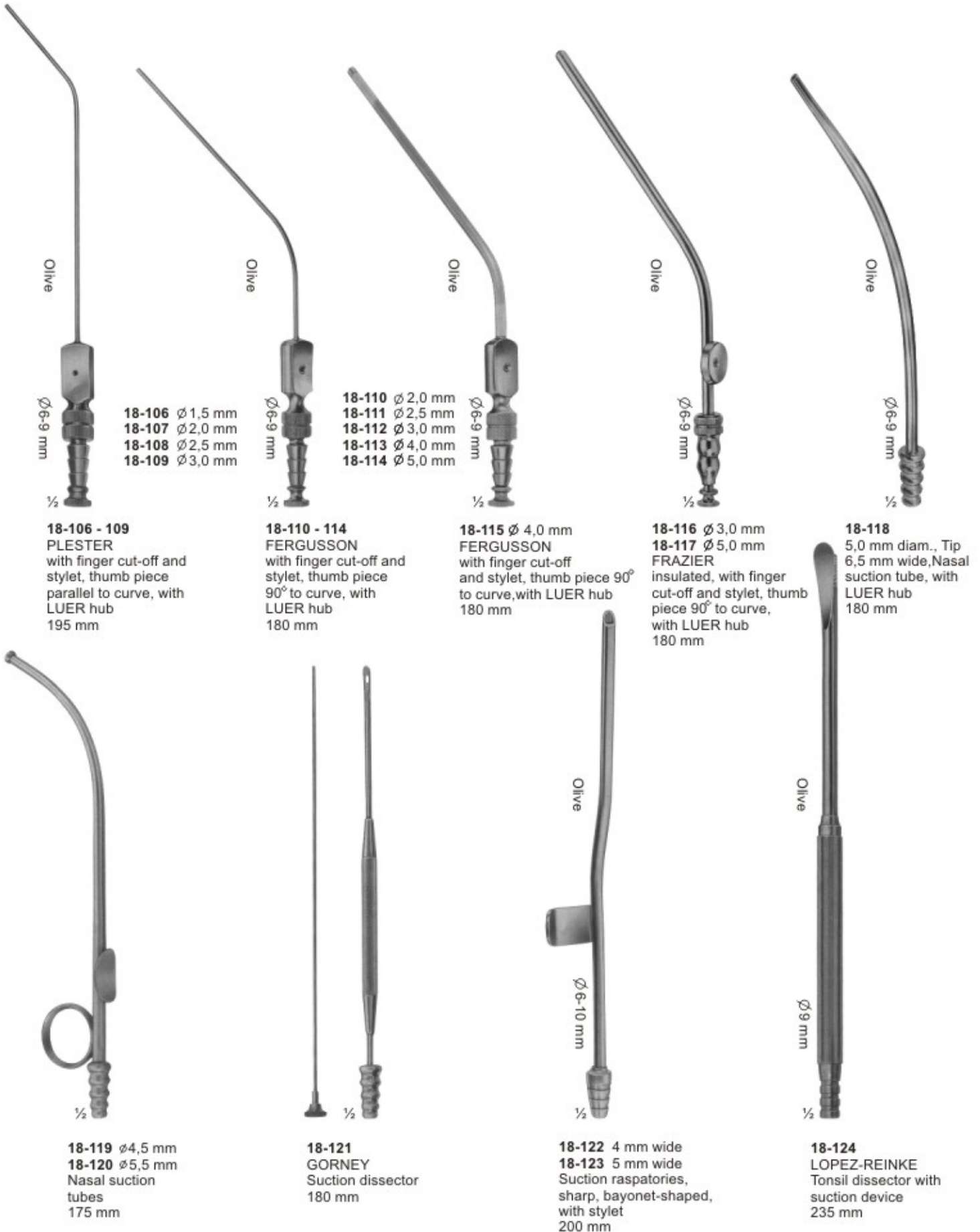



19-101 - 115
Schimmelbusch

Ø x H
sizes in mm

19-101	80 x 80
19-102	120 x 120
19-103	140 x 140
19-104	160 x 120
19-105	160 x 150
19-106	190 x 150
19-107	190 x 190
19-108	240 x 160
19-109	240 x 240
19-110	290 x 160
19-111	290 x 240
19-112	340 x 160
19-113	340 x 240
19-114	390 x 190
19-115	390 x 290



19-116
Box
(without Bulldog clamps,
without silicone tape)



19-117
Box with support
120 x 65 x 13 mm
(ohne Bulldogklemmen)



19-118
Box with support for
needle electrodes,
without instruments

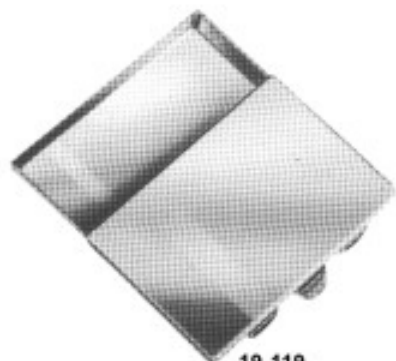

19-119
50 x 25 x 4,5 mm
19-120
65 x 42 x 8 mm
19-121
75 x 25 x 4,5 mm



19-122
Ø 65 mm x 15 mm



19-123-131

	Ø x H
19-123	30 x 90 mm
19-124	50 x 100 mm
19-125	50 x 130 mm
19-126	50 x 175 mm
19-127	50 x 100 mm
19-128	75 x 130 mm
19-129	75 x 175 mm
19-130	100 x 175 mm
19-131	100 x 200 mm



19-132-139

19-132	165 x 85 x 35 mm
19-133	200 x 100 x 35 mm
19-134	200 x 100 x 50 mm
19-135	230 x 130 x 50 mm
19-136	260 x 150 x 50 mm
19-137	270 x 235 x 50 mm
19-138	300 x 200 x 50 mm
19-139	235 x 275 x 50 mm

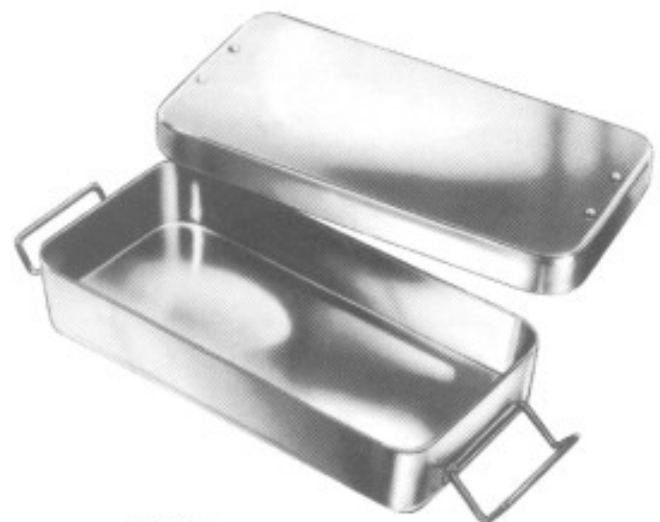

19-140
205 x 105 x 35 mm



19-141-142

- 19-141** Martin Sterilizing Forceps
consisting of:
1 Sterilizing Forceps, curved, 25 cm,
without ratchet, with lid for jar
1 jar with bottom plate (anti-tilt)
- 19-142** ditto, with 32 cm long Sterilizing Forceps

Round Metal Boxes and Medicine Cups



19-143-148

	Ø x H
19-143	75 x 60 mm
19-144	75 x 75 mm
19-145	100 x 60 mm
19-146	100 x 100 mm
19-146A	125 x 80 mm
19-147	125 x 125 mm
19-148	150 x 150 mm



19-149
25 cc

19-150
50 cc



19-151
20 cc
Medicine Spoon



19-152
Ø 75 x 12 mm
Tablet Tray



19-153
Ø 90 x 90 mm
Metal Cup



19-154
Ø 75 x 80 mm
Sputum Cup



Kidney Dish



19-155 - 157

19-155	170 x 100 x 35 mm
19-156	250 x 140 x 40 mm
19-157	275 x 150 x 45 mm



19-158 - 165



19-166 - 170

	Ø x H	
19-158	40 x 19 mm	0.05L
19-159	61 x 30 mm	0.07L
19-160	80 x 40 mm	0.14L
19-161	116 x 50 mm	0.35L
19-162	128 x 55 mm	0.45L
19-163	147 x 65 mm	0.70L
19-164	167 x 75 mm	1.10L
19-165	187 x 85 mm	1.60L

19-166	116 x 35 mm	0.30L
19-167	128 x 38 mm	0.40L
19-168	147 x 40 mm	0.50L
19-169	157 x 45 mm	0.75L
19-170	187 x 45 mm	1.00L



19-173 - 176

19-173	0,25L
19-174	0,50L
19-175	1,00L
19-176	2,00L



19-171
Ø 100 x 28 mm 0.15L



19-172
100 cc 0.1L



26-186
235 x 190 x 40 mm



26-187
Ø 220 x 70 mm



19-179
∅ 50 x 100 mm
Powder Pot



19-180
∅ 50 x 75 mm
Methot With Lid



19-181
∅ 50 x 75 mm
Methot Without Lid



19-182



19-183



19-184



19-185-186

19-185 ∅ 235 mm
19-186 ∅ 310 mm

Needle Cases



19-187
Sauerbruch
210 x 125 x 17 mm



19-188
Sauerbruch
210 x 125 x 17 mm



19-189
150 x 95 x 13 mm



19-190
150 x 95 x 13 mm



19-191
150 x 95 x 13 mm



19-192
150 x 95 x 13 mm



19-193
150 x 95 x 13 mm



19-194
150 x 95 x 13 mm

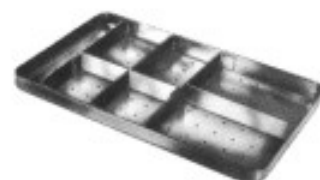

19-195
150 x 95 x 13 mm

Storing Cases



19-196
Deponette
245 x 135 x 35mm



19-197
Deponette
245 x 135 x 50mm



19-198
Deponette
245 x 135 x 60mm

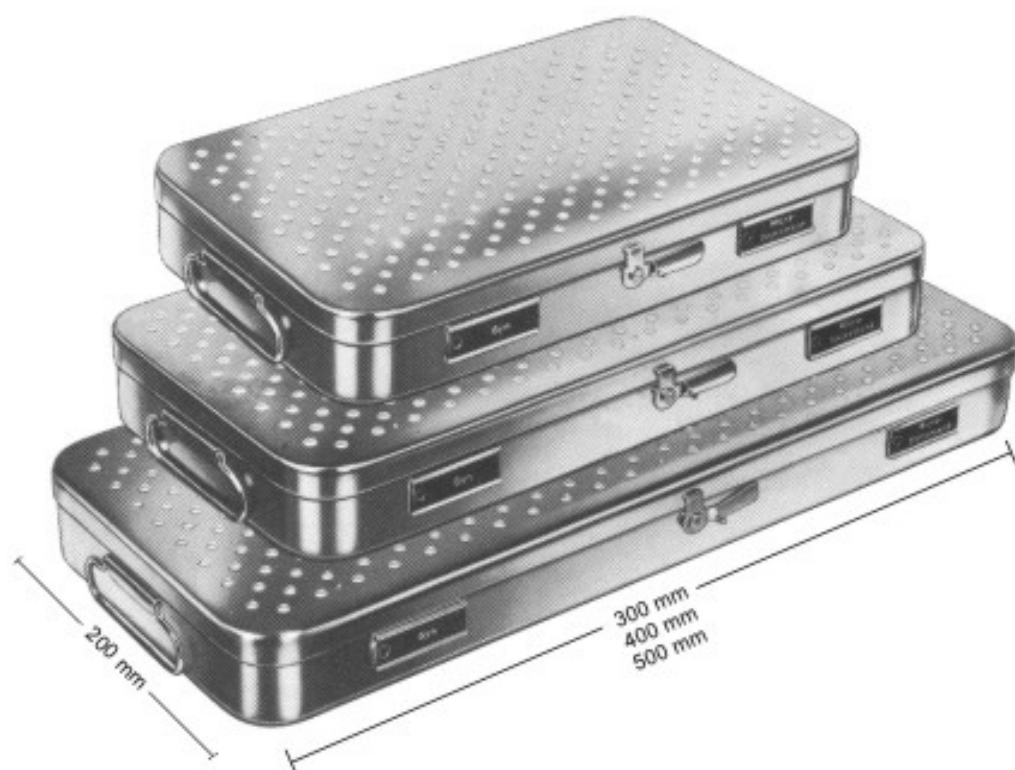

19-199 - 209

19-199	230 x 130 x 50 mm
19-200	260 x 150 x 50 mm
19-201	275 x 235 x 50 mm
19-202	300 x 200 x 50 mm
19-203	325 x 275 x 50 mm
19-204	420 x 175 x 50 mm
19-205	230 x 130 x 75 mm
19-206	260 x 150 x 75 mm
19-207	300 x 200 x 75 mm
19-208	325 x 275 x 75 mm
19-209	420 x 175 x 75 mm

Sterilizing Baskets / Trays



19-210 - 212

19-210	480 x 250 x 50 mm
19-211	520 x 250 x 75 mm
19-212	520 x 250 x 100 mm



19-213 - 218

19-213	240 x 240 x 50 mm
19-214	240 x 240 x 80 mm
19-215	240 x 240 x 100 mm
19-216	480 x 260 x 50 mm
19-217	520 x 260 x 80 mm
19-218	520 x 260 x 100 mm

Sterilizing Basket

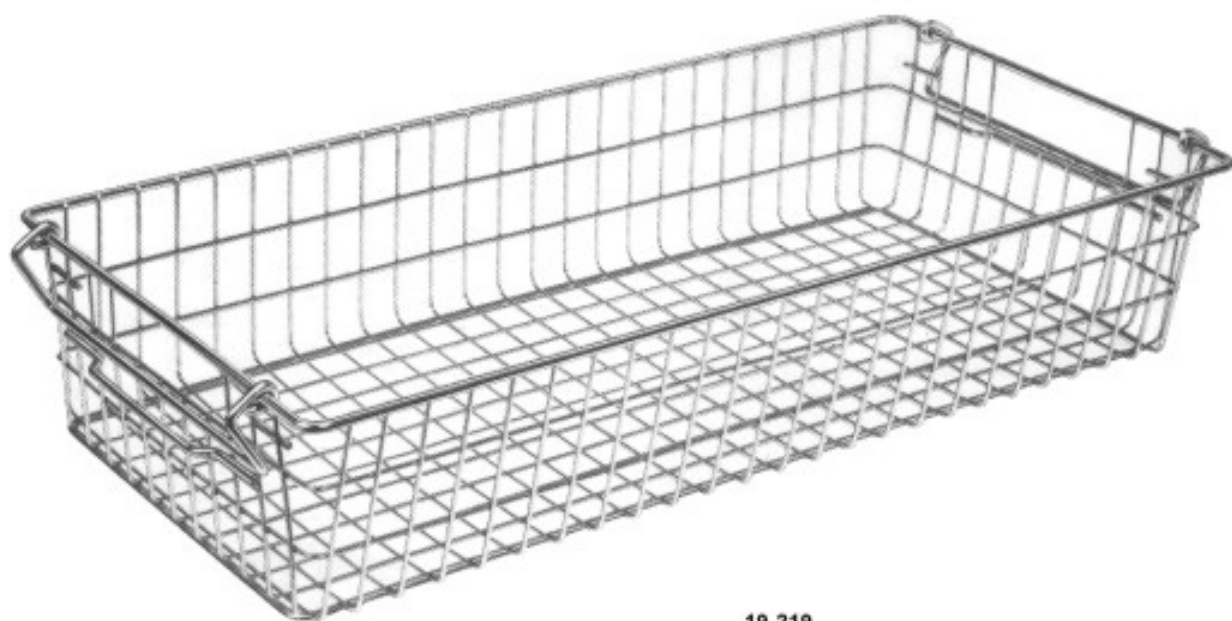

19-219
(60 x 30 x 15 cm)
Nominal dimensions

Scissors with Tungsten Carbide Inserts

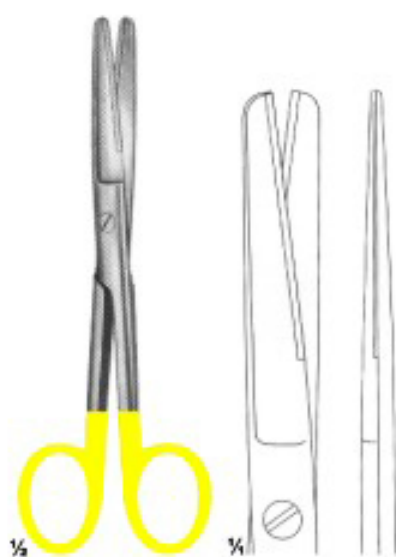

26-101
Standard

14,5cm
16,5cm
18,5cm



26-102
Standard

14,5cm
16,5cm
18,5cm

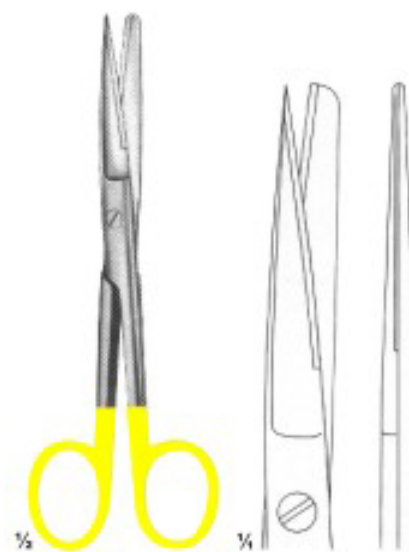

26-103
Standard

14,5cm
16,5cm
18,5cm



26-104
Standard

14,5cm
16,5cm
18,5cm

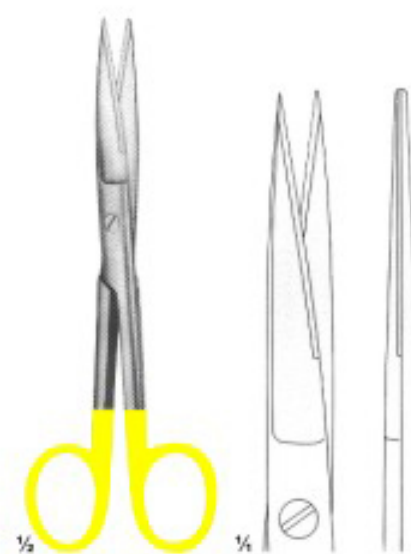

26-105
Standard

14,5cm
16,5cm
18,5cm



26-106
Standard

14,5cm
16,5cm
18,5cm

Scissors with Tungsten Carbide Inserts

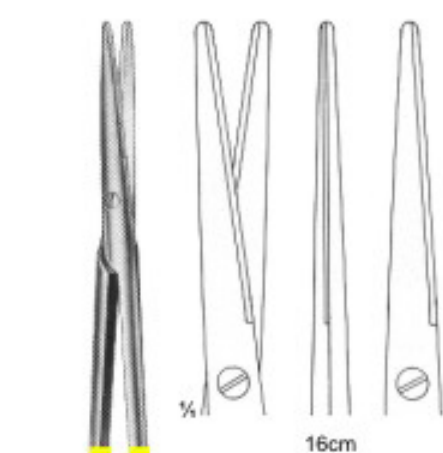

26-107
Mayo-Lexer

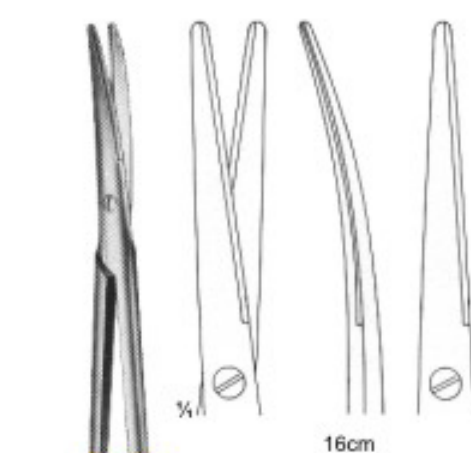

26-108
Mayo-Lexer

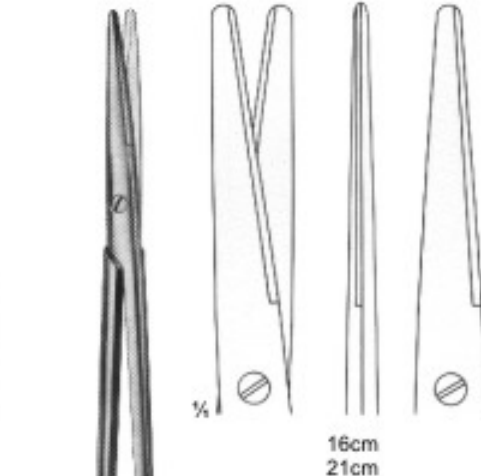

26-109
Lexer

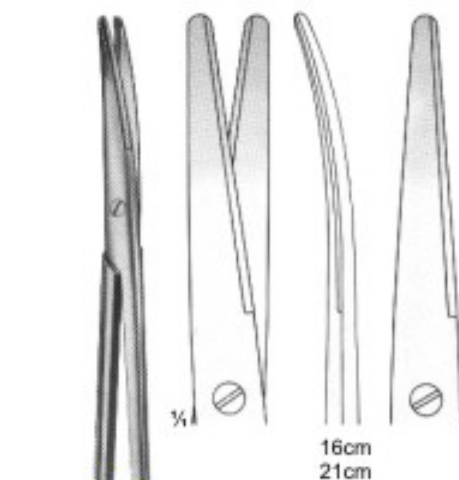

26-110
Lexer

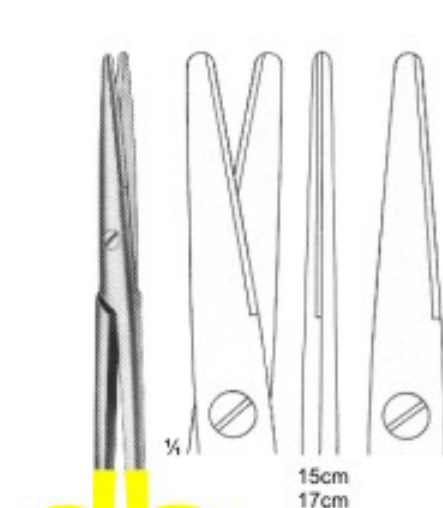

26-111
Mayo-Stille

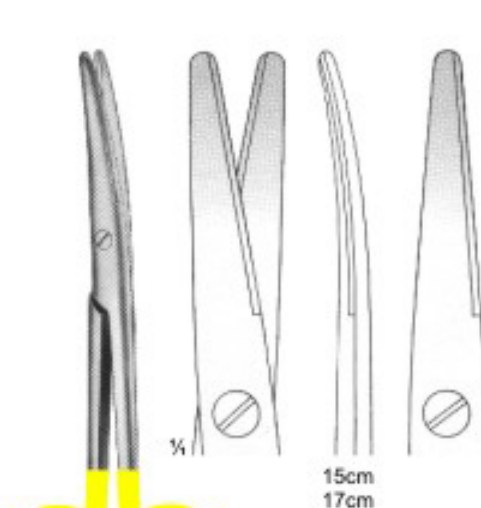

26-112
Mayo-Stille

Scissors with Tungsten Carbide Inserts

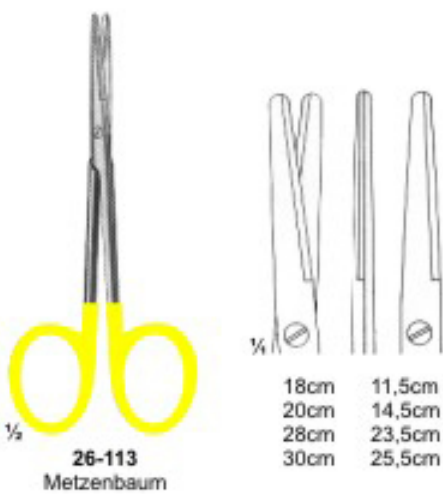

Scissors with Tungsten Carbide Inserts

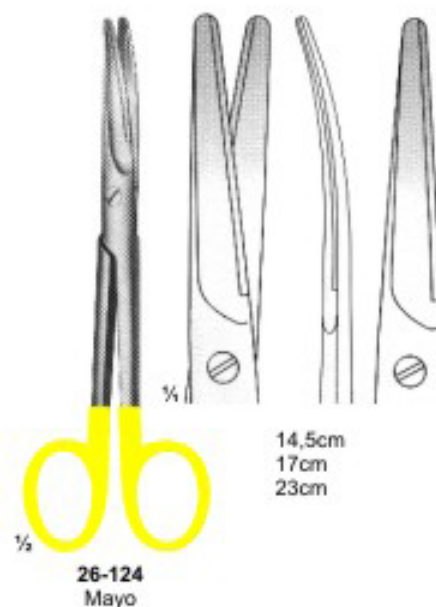
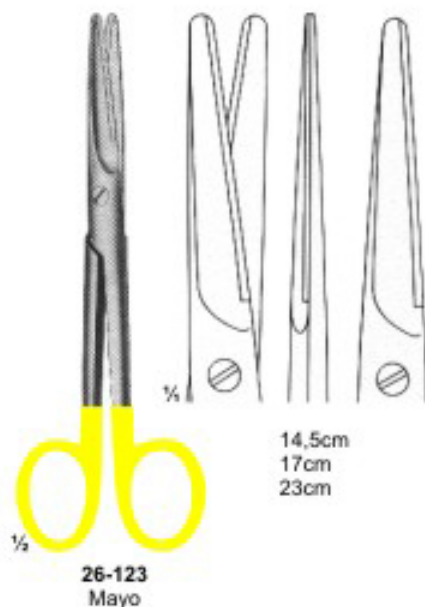
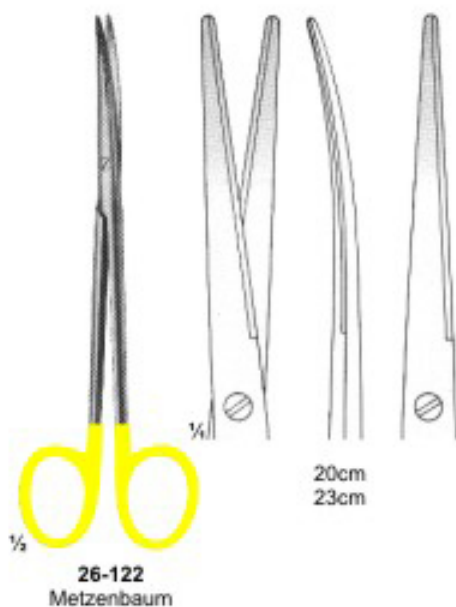
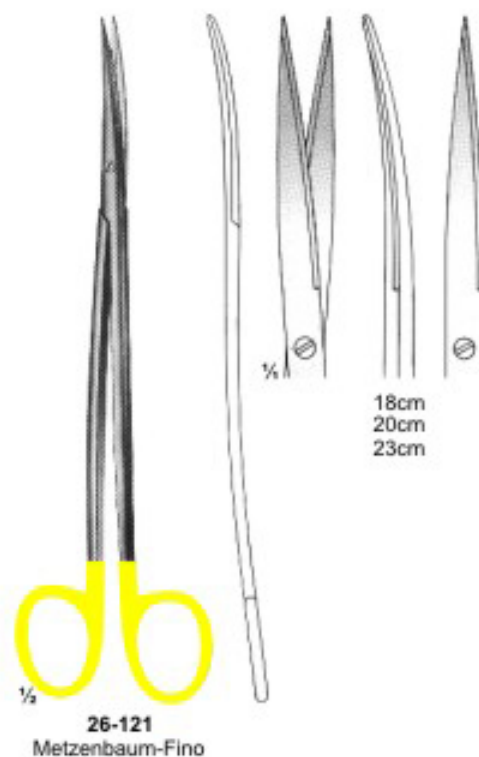
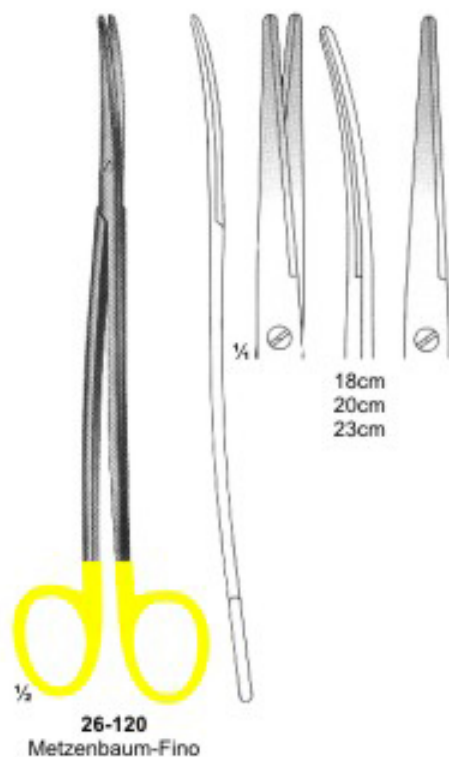
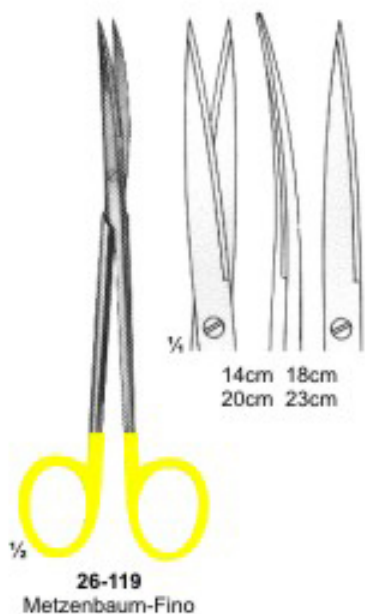

Scissors with Tungsten Carbide Inserts

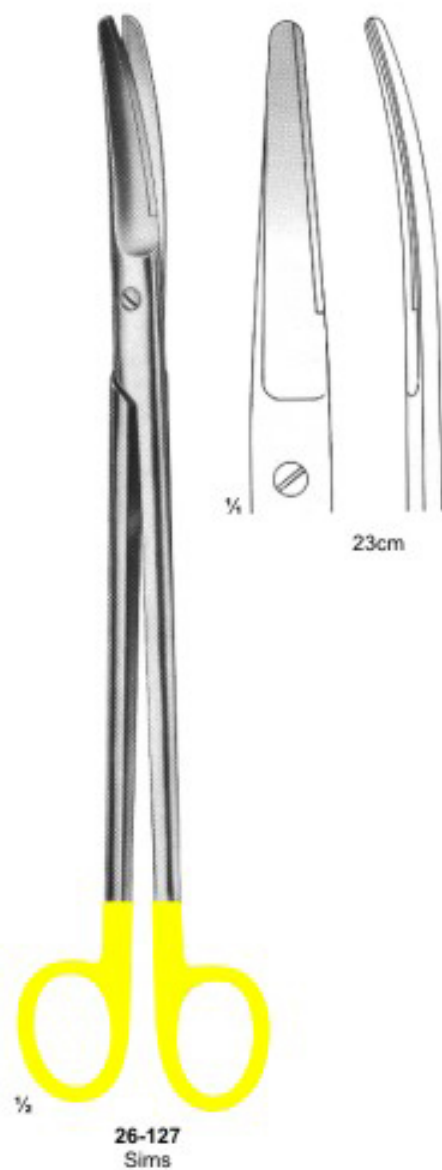
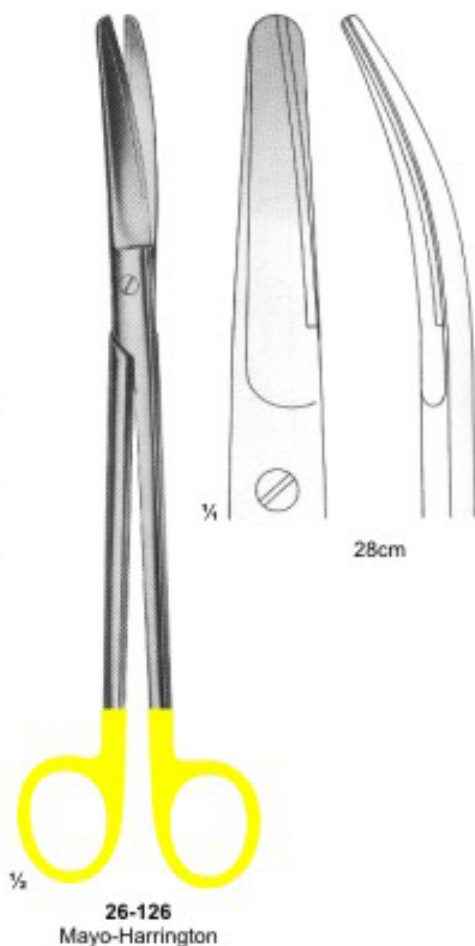
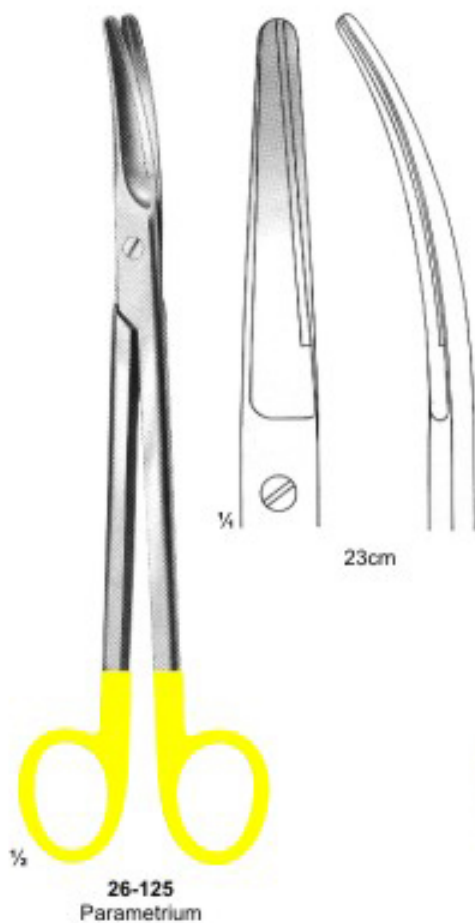

Scissors with Tungsten Carbide Inserts

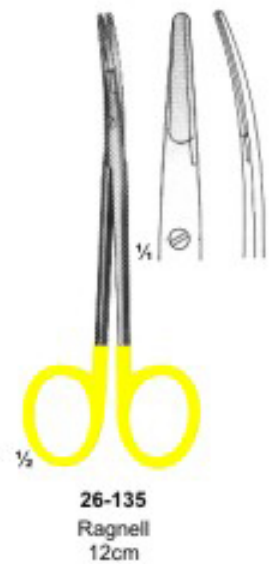
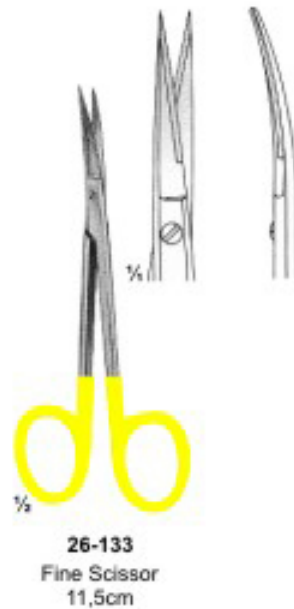
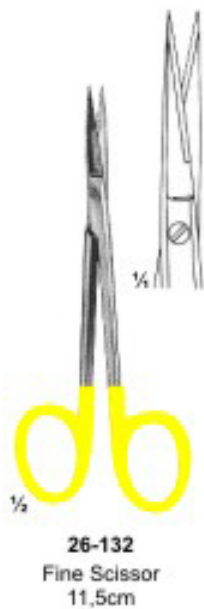
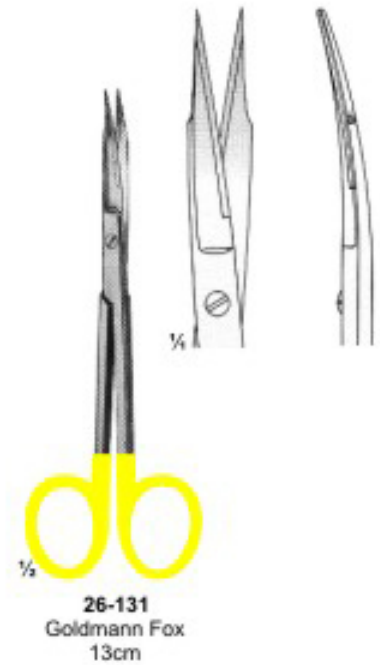

Scissors & Dissecting Forceps with Tungsten Carbide Inserts

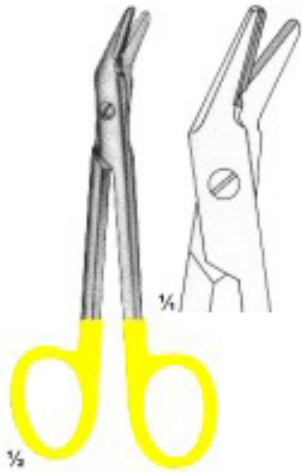

26-136
Universal
12cm

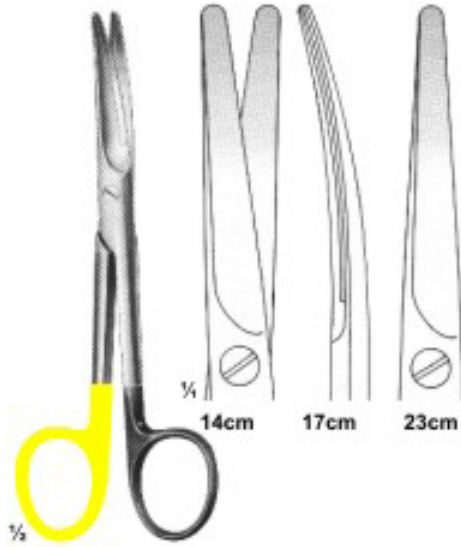

26-137
Ligature Scissors
1 Black & 1 Goldplated ring

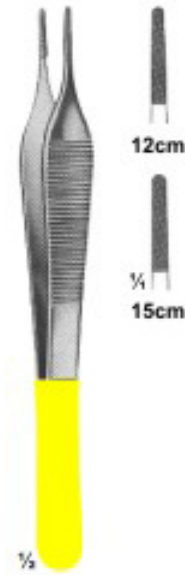

26-138
Adson



26-139
Cushing
17,5cm



26-140
Cushing
18cm



26-141
Cushing-Taylor
18cm



26-142
Dissecting Forceps
15cm



26-143
Semken
15cm

Dissecting Forceps and Needle holders with Tungsten Carbide Inserts



26-144
Wangensteen

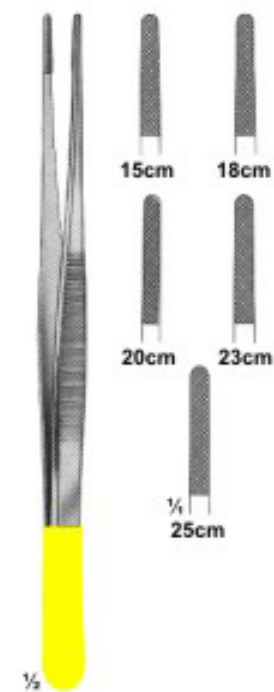

26-145
Potts-Smith

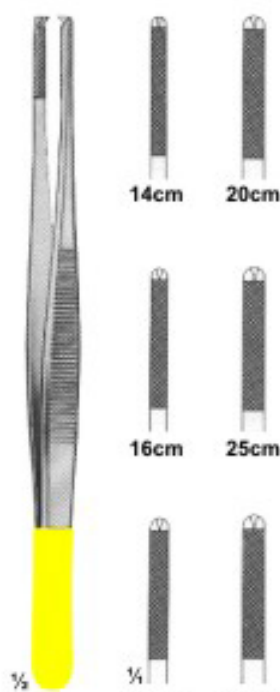

26-146
Oehler



26-147
Potts-Smith
22cm



26-148
Hepp-Scheidle
18cm



26-149
Castroviejo
14cm



26-150
Castroviejo
14cm



26-151
Arruga
16cm

Needle holders with Tungsten Carbide Inserts



E-mail: bsz@brain.net.pk

Tel: + 92 52 4580548

Fax: + 92 52 4582782



26-152
Arruga
16cm

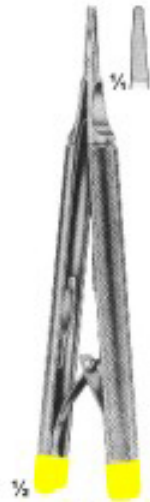

26-153
Castroviejo
13cm



26-154
Hegar
20cm 24cm

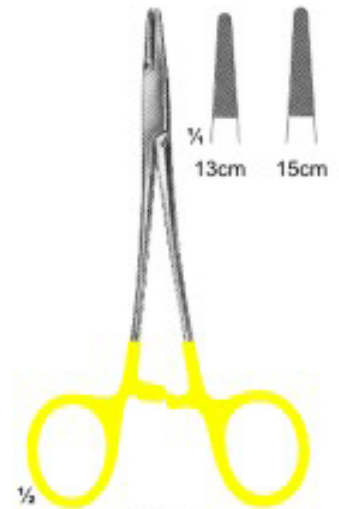

26-155
Halsey
13cm 15cm



26-156
Mayo-Hegar
16cm 18cm 20cm
24cm 26cm 30cm

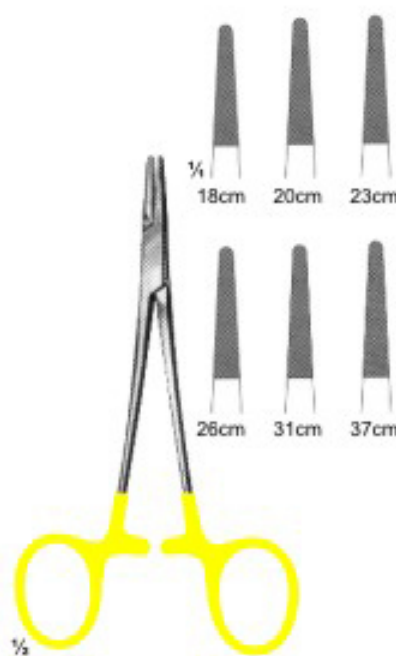

26-157
De-Bakey
18cm 20cm 23cm
26cm 31cm 37cm

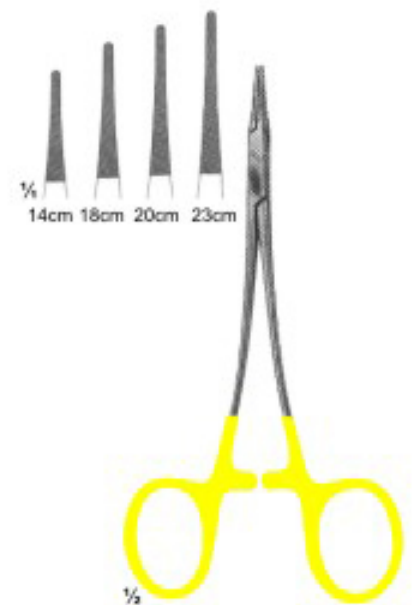

26-158
Hegar-Vascular
14cm 18cm
20cm 23cm

Needle holders with Tungsten Carbide Inserts

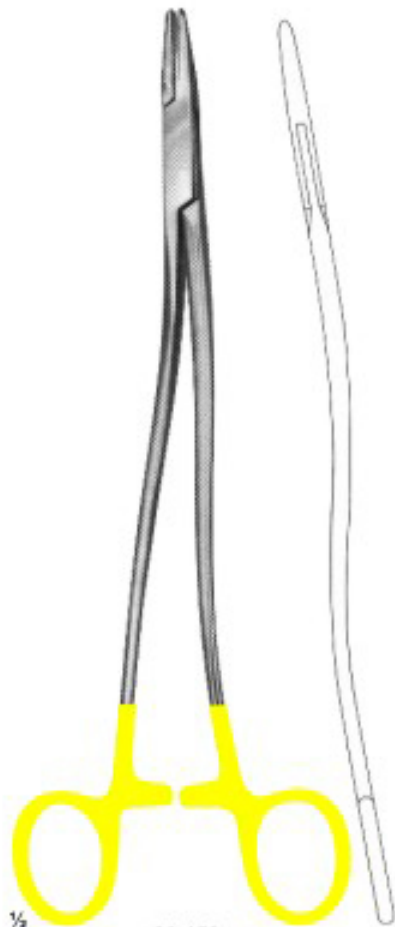

1/4
26-159
Bozemann-Wertheim
20cm 24cm 26cm



1/4
26-160
Stratte
22cm 23cm

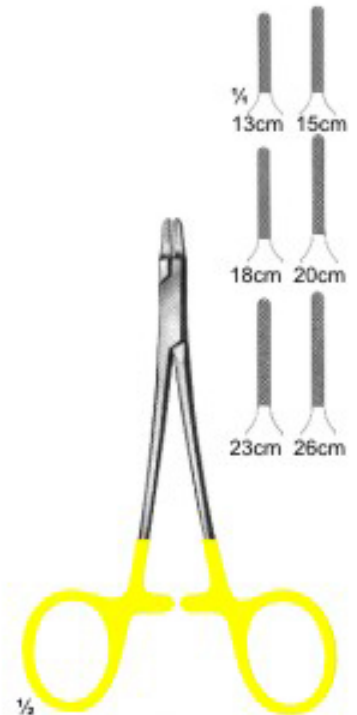

1/4
26-161
Ryder
13cm 15cm 18cm
20cm 23cm 26cm



1/4
26-162
Ryder-Vascular
13cm 15cm 18cm
20cm 23cm 26cm



1/4
26-163
Martin
15cm 17cm 20cm

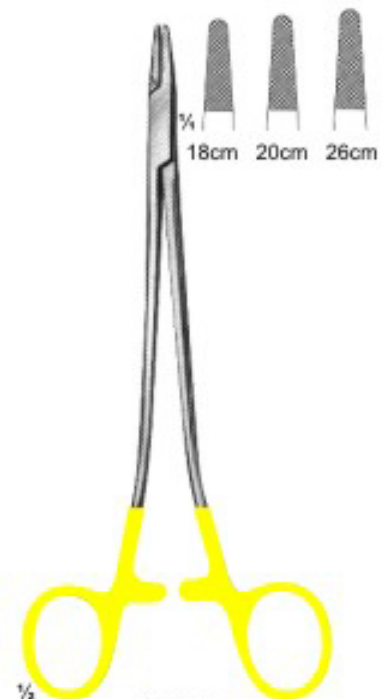

1/4
26-164
Sarot
18cm 20cm 26cm



Needle holders with Tungsten Carbide Inserts



26-172
Mathieu-Ryder
17cm
20cm 24cm



26-173
Lichtenberg
20cm



26-174
Langhals
20cm 25cm



26-175
Lichtenberg
20cm 25cm



26-176
Luehty-Beck
20cm 25cm



26-177
Luehty-Beck
20cm 25cm



26-178
Langebeck
18cm
20cm 23cm

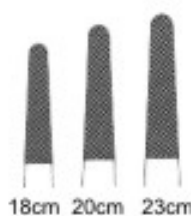

26-179
Langebeck-beck
18cm
20cm 23cm